

PERFILMASTER.COM.BR



PERFIL
MASTER
DIVISÃO ENERGIA SOLAR

04 / 05

PRODUTOS

06

EMBALAGEM

07/08

APRESENTAÇÃO

09/10/11/12/13

KIT DE FIXAÇÃO TELHA COLONIAL

PES 0005

PES 0033

14/15/16

SUPOORTE FIXAÇÃO TELHA
COLONIAL - PERFIL C

PES 0044

17/18/19

KIT DE FIXAÇÃO TELHA
FIBROCIMENTO E METALICA -
VIGA METÁLICA

PES 0006

PES 0007

20/21

KIT FIXAÇÃO TELHA FIBROCIMENTO
E METÁLICA - VIGA METÁLICA PES
0034

PES 0034

22/23/24

SUPOORTE DE FIXAÇÃO TELHA
FIBROCIMENTO E METÁLICA - PERFIL C

PES 0046

25/26/27

KIT FIXAÇÃO TELHA FIBROCIMENTO E
METÁLICA - VIGA DE MADEIRA

PES 0007

PES 0035

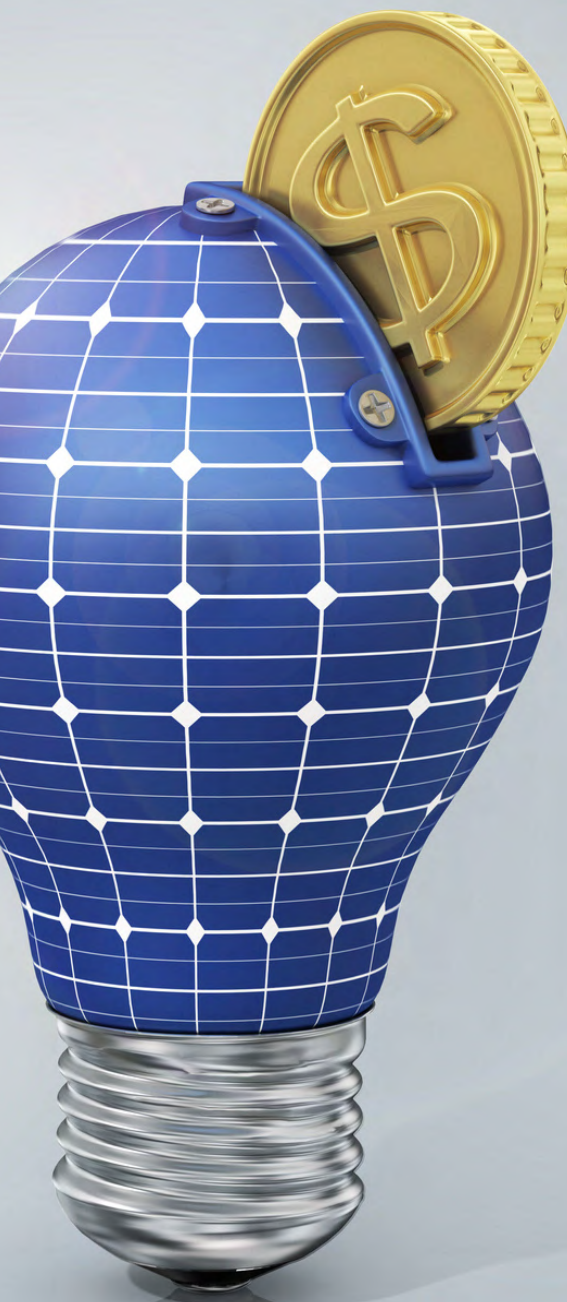

ÍNDICE

CATÁLOGO DE PRODUTOS

28/29/30

SUPORE DE FIXAÇÃO TELHA FIBROCIMENTO E METÁLICA - VIGA MADEIRA - PERFIL C

PES 0045

31/32

KIT FIXAÇÃO TELHA FIBROCIMENTO E METÁLICA - VIGA DE MADEIRA

PES 0035

33/34/35

KIT FIXAÇÃO PARA TELHA ONDULADA

PES 0014

36/37/38

KIT FIXAÇÃO MINI TRILHO

PES 0022

PES 0020

39

COMPOSIÇÃO KIT SUPORTE KALHETÃO

PES 0026

40/41/42

SUPORE PARA SOLO

PES 0023 - 4 MÓDULOS

PES 0031 - 8 MÓDULOS

43

SUPORE DE LAJE, ALUMÍNIO - 4 MÓDULOS

PES 0013

44

CARPOR KIT PARA 15 MÓDULOS

PES 0028

ÍNDICE

CATÁLOGO DE PRODUTOS

30

SUIPORTE DE SOLO 4 E 8 MÓDULOS

PES 0023

PES 0031

31

PES 0012

PES 0023

32

PES 0031

33

SUPORTE DE LAJE EM ALUMÍNIO
PARA 4 MÓDULOS

PES 0013

34

CARPORT KIT PARA 15 MÓDULOS

PES 0028

Nossos Produtos



Suporte Z

Código: PES 0001



Fixador Final

Código: PES 0002



Fixador Central

Código: PES 0003



Perfil H

Código: PES 0004 (4400 M)

Código: PES 0010 (4800 M)

Código: PES 0011 (2400 M)

Código: PES 0019 (2200 M)



Parafuso rosca dupla

Código: PES 0008 metal

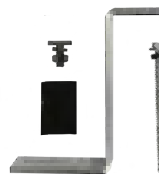

Suporte S

Código: PES 0015



Parafuso rosca dupla

Código: PES 0009 madeira



Perfil C

Código: PES 0025 (2200 M)

Código: PES 0029 (4800 M)

Código: PES 0030 (4400 M)

Código: PES 0036 (4800 M)

Código: PES 0036 (3600 M)



Parafuso rosca dupla

Código: PES 0039



Parafuso rosca dupla

Código: PES 0045



Parafuso rosca dupla

Código: PES 0046



Fixador Cental U

Código: PES 0016

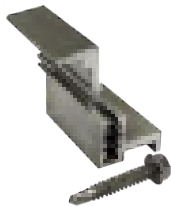

Fixador com Regulagem

Código: PES 0017



Junção Perfil H

Código: PES 0018



KIT de fixação Mini Trilho

Código: PES 0022

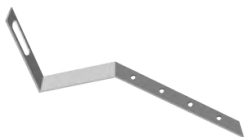

Suporte para Telhado Kalhetão

Código: PES 0026

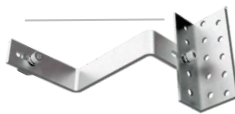

Suporte z

Código: PES 0044



Fixador Central

Código: PES 0042



Fixador com regulagem

Código: PES 0043



Suporte

Código: PES 0038



Parafuso T

Código: PES 0021

Padrão de Embalagem



Pensando na praticidade e qualidade de nossos produtos.

Utilizamos o Padrão de Embalagem onde todas as peças são embaladas e identificadas em caixas individuais sempre em múltiplos, facilitando a logística interna do cliente e a expedição.

Os fixadores Fibrocimento, Madeira, Metal, Suporte “Z” e “S” em caixas com 8 unidades.

Os Clamps Centrais, caixas com 6 unidades e os Clamps Finais caixas com 4 unidades.



A PERFILMASTER está no mercado desde 2014, integrando um grupo de empresas que atua no segmento da construção civil há 50 anos.

Extrusora



Especializada no ciclo de produção de perfis de alumínio da extrusão ao acabamento, para diversos segmentos do mercado.

Iniciando em 2021 no segmento de ENERGIA SOLAR com perfis e fixadores para MÓDULOS FOTOVOLTAICOS.

Além da extrusão de perfis a PERFILMASTER atua no tratamento de superfície dos mesmos com PINTURA ELETROSTÁTICA.

Pintura Eletrostática



NOSSA POLÍTICA DE QUALIDADE:

Fabricar produtos com a melhor relação custo/benefício, com eficiência e em conformidade com os procedimentos, normas técnicas e socioambientais. Cumprir os requisitos negociados, com objetivo de garantir a satisfação dos nossos clientes.

PRODUTOS EM ALUMÍNIO/AÇO INOXIDÁVEL.



Alta durabilidade
Fácil instalação e ajuste

O alumínio apresenta alta performance e propriedades mecânicas que garantem a segurança em sua aplicação, respeitando as normas vigentes para o segmento. Sua composição química apresenta versatilidade, resistência à corrosão, durabilidade e reciclabilidade.





Kit fixação Telha colonial

Código: PES 0005
PES 0033

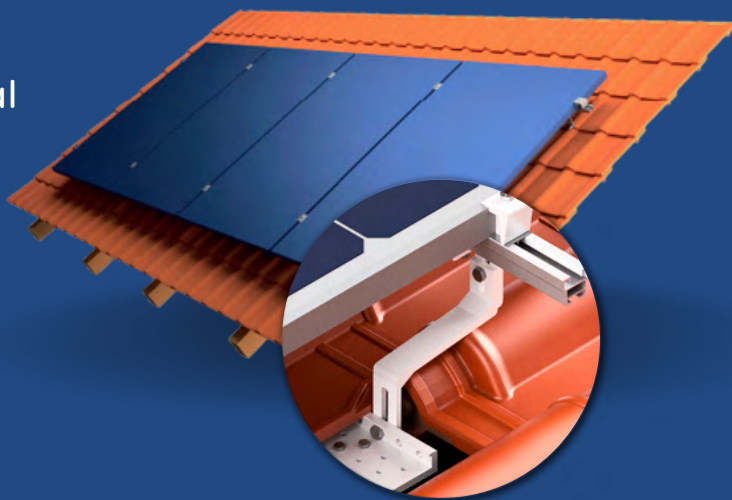

Composição Kit fixação Telha colonial - PES 0005 para 4 módulos



Suporte Z

8 Unidades

Possui ajustes de altura.



Perfil H

2 Unidades

Disponível nos tamanhos

- 2,2 Metros
- 2,4 Metros
- 4,4 Metros
- 4,8 Metros



Fixador central

6 Unidades



Fixador Final

4 Unidades

Ficha técnica PES 0005 -



Suporte Z



ARRUELA DE PRESSÃO M8 DIN 127 INOX 24 peças



PORCA SEXT M8 DIN 934 INOX 24 peças



PARAFUSO T M8X20 INOX 08 peças



PARAFUSO FRANCÊS M8 X 20 DIN 603 16 peças



PARAFUSO SEXTAVADO ROSCA SOBERBA M6 X 50MM 24 peças



Fixador Final



PARAFUSO CIL SX INT M6 X 40 DIN 912 INOX 04 peças



PORCA QUADRADA M6 DIN 557 INOX 04 peças



ARRUELA DE PRESSÃO M6 DIN 127 INOX 04 peças



Fixador Central



PARAFUSO CIL SX INT M6 X 40 DIN 912 INOX 06 peças



PORCA QUADRADA M6 DIN 557 INOX 06 peças



ARRUELA DE PRESSÃO M6 DIN 127 INOX 06 peças

Composição Kit fixação Telha colonial - PES 0033 para 2 módulos



Suporte Z

4 Unidades

Possui ajustes de altura.

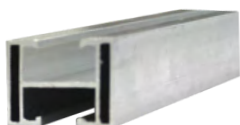

Perfil H

2 Unidades

Disponível nos tamanhos

- 2,2 Metros
- 2,4 Metros
- 4,4 Metros
- 4,8 Metros



Fixador central

2 Unidades



Fixador Final

4 Unidades

Ficha técnica PES 0033



Suporte Z



ARRUELA DE PRESSÃO M8 DIN 127 INOX

12 peças



PORCA SEXT M8 DIN 934 INOX

12 peças



PARAFUSO T M8X20 INOX

04 peças



PARAFUSO FRANCÊS M8 X 20 DIN 603

08peças



PARAFUSO SEXTAVADO ROSCA SOBERBA M6 X 50MM

12 peças



Fixador Final



PARAFUSO CIL SX INT M6 X 40 DIN 912 INOX

04 peças



PORCA QUADRADA M6 DIN 557 INOX

04 peças



ARRUELA DE PRESSÃO M6 DIN 127 INOX

04 peças



Fixador Central



PARAFUSO CIL SX INT M6 X 40 DIN 912 INOX

02 peças



PORCA QUADRADA M6 DIN 557 INOX

02 peças



ARRUELA DE PRESSÃO M6 DIN 127 INOX

02 peças



Suporte fixação para telha colonial - Perfil C

Código: PES 0044

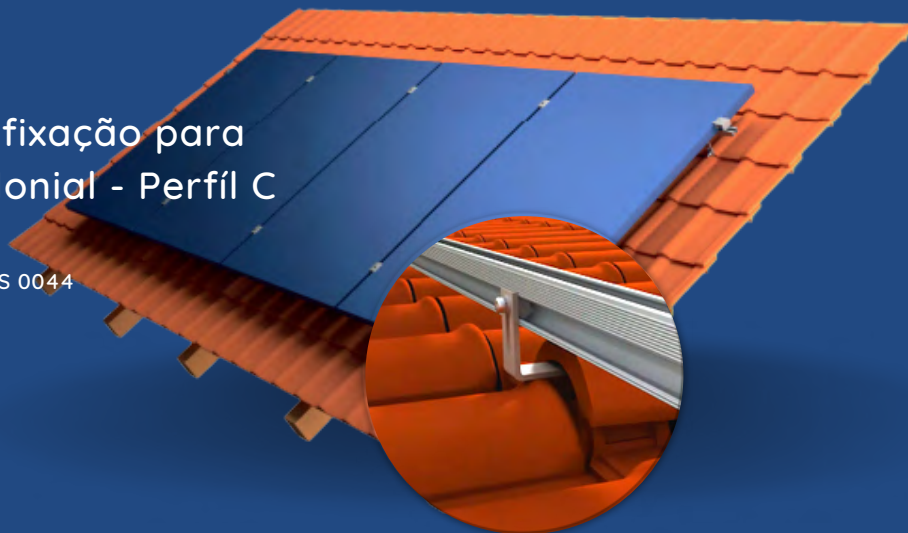

Composição para fixador Telha colonial - PES 004 4 para 4 módulos



PES 004 4

Suporte

8 Unidades

Possui ajustes de altura.

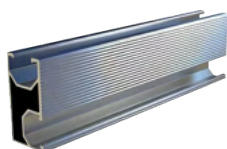

Perfil C

2 Unidades

Disponível nos tamanhos

- 2,2 Metros
- 2,4 Metros
- 4,4 Metros
- 4,8 Metros



**Fixador
central**

6 Unidades

PES 0042

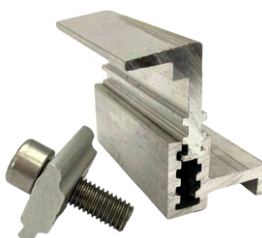

**Fixador
Final**

4 Unidades

PES 0043

Ficha técnica PES 0044



Suporte



ARRUELA DE PRESSÃO M8 DIN 127 INOX

16 peças



PORCA SEXT M8 DIN 934 INOX

08 peças



PARAFUSO FRANCÊS M8 X 20 DIN 603

08 peças



Fixador Final



PARAFUSO CIL SX INT M8X25 DIN 912 INOX

04 peças



CONECTOR CLAMP

04 peças



Fixador Central



PARAFUSO CIL SX INT M8X25 DIN 912 INOX

06 peças



CONECTOR CLAMP

06 peças



Kit fixação telha fibrocimento
e metálica - Viga metálica

Código: PES 0006
PES 0034

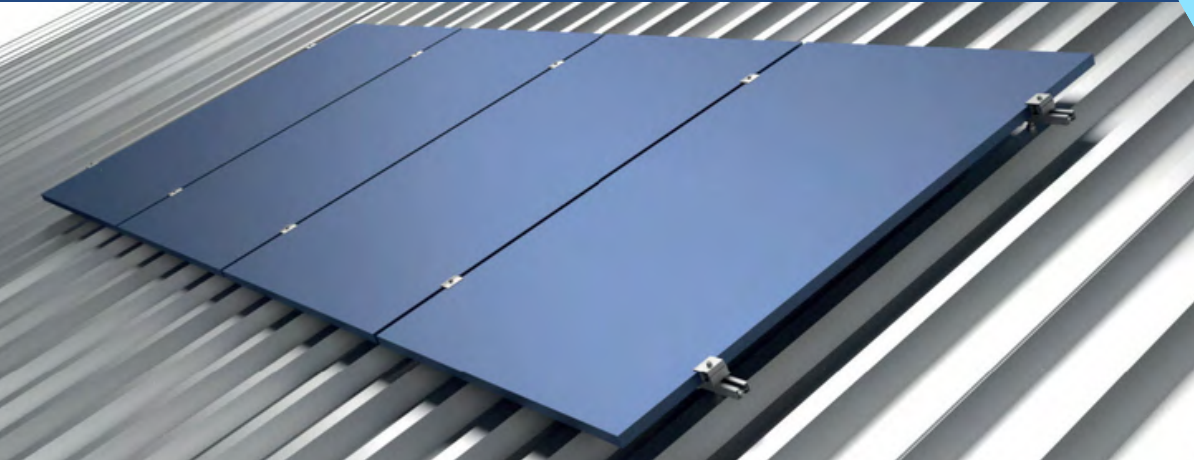

Composição Kit fixação telha fibrocimento e metálica - Viga metálica PES 0006 para 4 módulos



Parafuso rosca dupla

8 Unidades

Parafuso rosca dupla 250 milímetros de comprimento em inox, com base de alumínio.

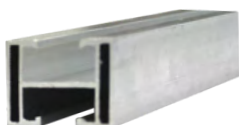

Perfil H

2 Unidades

Disponível nos tamanhos

- 2,2 metros
- 2,4 Metros
- 4,4 Metros
- 4,8 Metros



Fixador central

6 Unidades

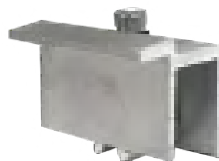

Fixador Final

4 Unidades

Ficha técnica PES 0006



Parafuso rosca dupla



ARRUELA DE PRESSÃO M8 DIN 127 INOX

08 peças



PORCA SEXT M8 DIN 934 INOX

08 peças



PARAFUSO T M8X20 INOX

08 peças



PORCA FLANGEADA M8 INOX

24 peças



ARRUELA DE VEDAÇÃO EDMP M10

08 peças



BASE DE ALUMÍNIO - 31,50MM X 80MM X 5MM

08 peças



Fixador Final



PARAFUSO CIL SX INT M6 X 40 DIN 912 INOX

04 peças



PORCA QUADRADA M6 DIN 557 INOX

04 peças



ARRUELA DE PRESSÃO M6 DIN 127 INOX

04 peças



Fixador Central



PARAFUSO CIL SX INT M6 X 40 DIN 912 INOX

06 peças



PORCA QUADRADA M6 DIN 557 INOX

06 peças



ARRUELA DE PRESSÃO M6 DIN 127 INOX

06 peças

Composição Kit fixação telha fibrocimento e metálica - Viga metálica PES 0034 para 2 módulos



Parafuso rosca dupla

4 Unidades

Parafuso rosca dupla 250 milímetros de comprimento em inox, com base de alumínio.

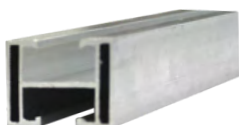

Perfil H

2 Unidades

Disponível nos tamanhos

- 2,2 metros
- 2,4 Metros
- 4,4 Metros
- 4,8 Metros



Fixador central

2 Unidades



Fixador Final

4 Unidades

Ficha técnica PES 0034



Parafuso rosca dupla



ARRUELA DE PRESSÃO M8 DIN 127 INOX

04 peças



PORCA SEXT M8 DIN 934 INOX

04 peças



PARAFUSO T M8X20 INOX

04 peças



PORCA FLANGEADA M8 INOX

12 peças



ARRUELA DE VEDAÇÃO EDMP M10

04 peças



BASE DE ALUMÍNIO - 31,50MM X 80MM X 5MM

04 peças



Fixador Final



PARAFUSO CIL SX INT M6 X 40 DIN 912 INOX

04 peças



PORCA QUADRADA M6 DIN 557 INOX

04 peças



ARRUELA DE PRESSÃO M6 DIN 127 INOX

04 peças



Fixador Central



PARAFUSO CIL SX INT M6 X 40 DIN 912 INOX

02 peças



PORCA QUADRADA M6 DIN 557 INOX

02 peças



ARRUELA DE PRESSÃO M6 DIN 127 INOX

02 peças



Suporte fixação telha fibrocimento
e metálica - Viga metálica - perfil C

Código: PES 0046

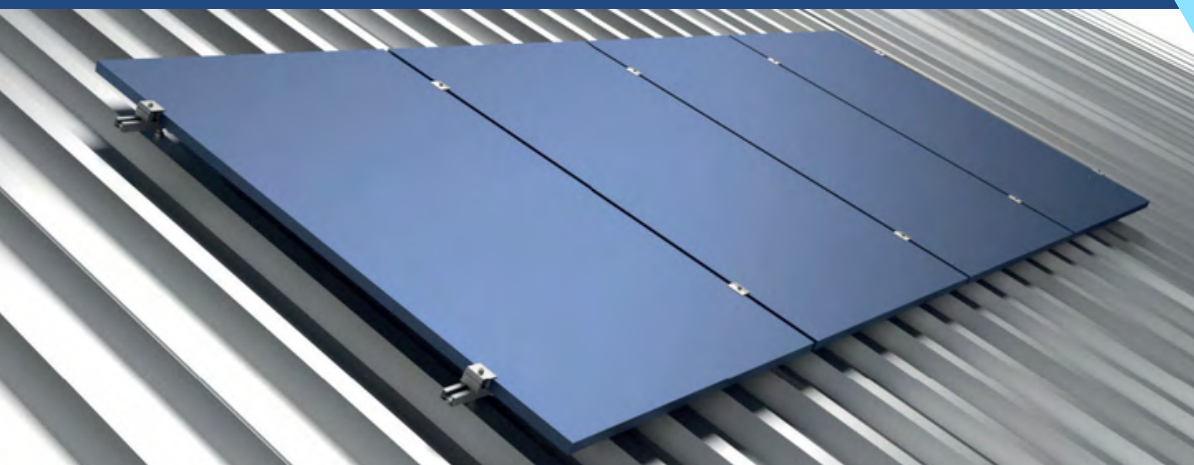

Composição Suporte fixação telha fibrocimento e metálica

- Viga metálica

PES 0046



Parafuso rosca dupla

8 Unidades

Parafuso rosca dupla 250 milímetros de comprimento em inox, com base de alumínio em L.



Perfil C

2 Unidades

Disponível nos tamanhos

- 2,2 metros
- 2,4 Metros
- 4,4 Metros
- 4,8 Metros



Fixador central

6 Unidades

PES 0042

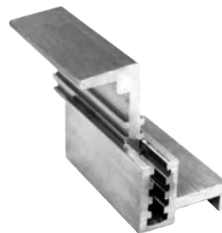

Fixador Final

4 Unidades

PES 0043

Ficha técnica PES 0046



Parafuso rosca dupla



ARRUELA DE PRESSÃO M8 DIN 127 INOX

08 peças



PORCA FLANGEADA M8 INOX

24 peças



ARRUELA DE VEDAÇÃO EDMP M10

08 peças



BASE DE ALUMÍNIO - 31,50MM X 80MM X 5MM

08 peças



Fixador Final



PARAFUSO CIL SX INT M8 X 25 DIN 912 INOX

04 peças



conector clamps

04 peças



Fixador Central



PARAFUSO CIL SX INT M8 X 25 DIN 912 INOX

06 peças



conector clamps

06 peças



PERFIL

MASTER

DIVISÃO ENERGIA SOLAR

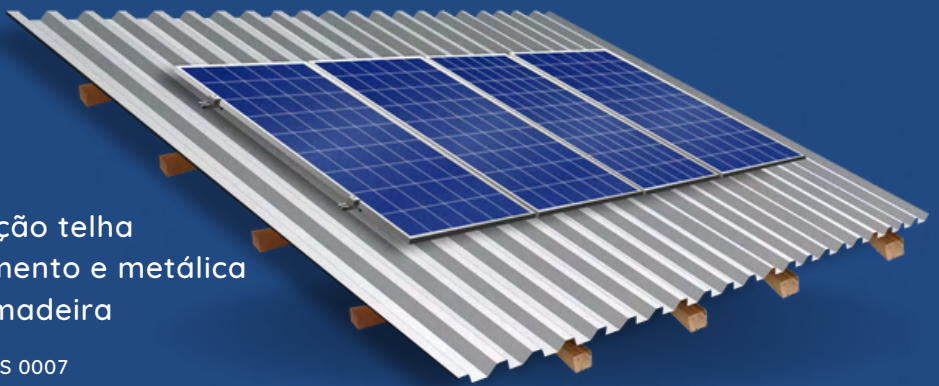

Kit fixação telha
fibrocimento e metálica
- Viga madeira

Código: PES 0007
PES 0035

Composição Kit fixação telha fibrocimento e metálica - Viga madeira PES 0007 para 4 módulos



Parafuso rosca dupla

8 Unidades

Parafuso rosca dupla 250 milímetros de comprimento em inox, com base de alumínio.

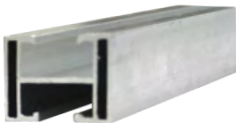

Perfil H

2 Unidades

Disponível nos tamanhos

- 2,2 metros
- 2,4 Metros
- 4,4 Metros
- 4,8 Metros



Fixador central

6 Unidades



Fixador Final

4 Unidades

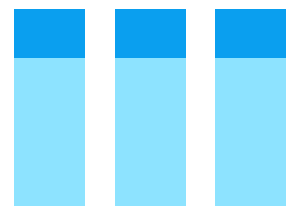

Ficha técnica PES 0007



Parafuso rosca dupla



ARRUELA DE PRESSÃO M8 DIN 127 INOX

08 peças



PORCA SEXT M8 DIN 934 INOX

08 peças



PARAFUSO T M8X20 INOX

08 peças



PORCA FLANGEADA M8 INOX

24 peças



ARRUELA DE VEDAÇÃO EDMP M10

08 peças



BASE DE ALUMÍNIO - 31,50MM X 80MM X 5MM

08 peças



Fixador Final



PARAFUSO CIL SX INT M6 X 40 DIN 912 INOX

04 peças



PORCA QUADRADA M6 DIN 557 INOX

04 peças



ARRUELA DE PRESSÃO M6 DIN 127 INOX

04 peças



Fixador Central



PARAFUSO CIL SX INT M6 X 40 DIN 912 INOX

06 peças



PORCA QUADRADA M6 DIN 557 INOX

06 peças



ARRUELA DE PRESSÃO M6 DIN 127 INOX

06 peças

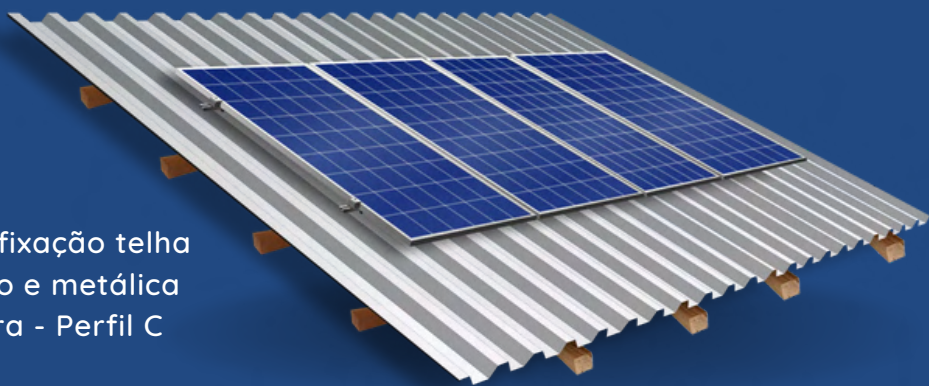

Suporte de fixação telha
fibrocimento e metálica
Viga madeira - Perfil C

Código: PES 0045

Composição suporte de fixação telha fibrocimento e metálica - Viga madeira PES 00045 para 4 módulos



Parafuso rosca dupla

8 Unidades

Parafuso rosca dupla 250 milímetros de comprimento em inox, com base "L" de alumínio.



Perfil C

2 Unidades

Disponível nos tamanhos

- 2,2 metros
- 2,4 Metros
- 4,4 Metros
- 4,8 Metros



Fixador central

6 Unidades

PES 0042



Fixador Final

4 Unidades

PES 0043

Ficha técnica PES 0045



Parafuso rosca dupla



ARRUELA DE PRESSÃO M8 DIN 127 INOX

08 peças



PORCA FLANGEADA M8 INOX

24 peças



ARRUELA DE VEDAÇÃO EDMP M10

08 peças



BASE DE ALUMÍNIO - 80MM X 80MM X 5MM

08 peças



Fixador Final



PARAFUSO CIL SX INT M8 X 25 DIN 912 INOX

04 peças



conector clamps

04 peças



Fixador Central



PARAFUSO CIL SX INT M8 X 25 DIN 912 INOX

06 peças



conector clamps

06 peças

Composição Kit fixação telha fibrocimento e metálica - Viga madeira PES 0035 para 2 módulos

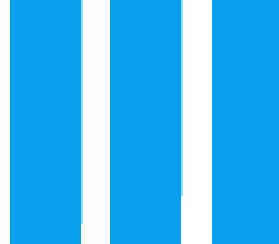

Parafuso rosca dupla

4 Unidades

Parafuso rosca dupla 250 milímetros de comprimento em inox, com base de alumínio.

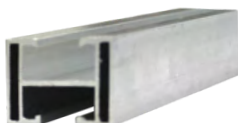

Perfil H

2 Unidades

Disponível nos tamanhos

- 2,2 metros
- 2,4 Metros
- 4,4 Metros
- 4,8 Metros



Fixador central

2 Unidades



Fixador Final

4 Unidades

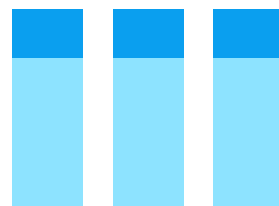

Ficha técnica PES 0035



Parafuso rosca dupla



ARRUELA DE PRESSÃO M8 DIN 127 INOX

04 peças



PORCA SEXT M8 DIN 934 INOX

04 peças



PARAFUSO T M8X20 INOX

04 peças



PORCA FLANGEADA M8 INOX

12 peças



ARRUELA DE VEDAÇÃO EDMP M10

04 peças



BASE DE ALUMÍNIO - 31,50MM X 80MM X 5MM

04 peças



Fixador Final



PARAFUSO CIL SX INT M6 X 40 DIN 912 INOX

04 peças



PORCA QUADRADA M6 DIN 557 INOX

04 peças



ARRUELA DE PRESSÃO M6 DIN 127 INOX

04 peças



Fixador Central



PARAFUSO CIL SX INT M6 X 40 DIN 912 INOX

02 peças



PORCA QUADRADA M6 DIN 557 INOX

02 peças



ARRUELA DE PRESSÃO M6 DIN 127 INOX

02 peças

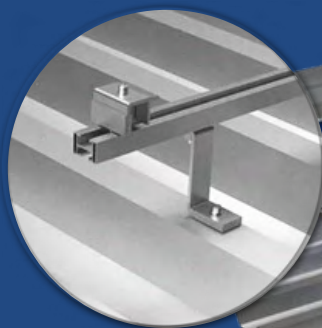

Kit fixação para
telha ondulada

Código: PES 00014

Composição Kit fixação telha ondulada - PES0014

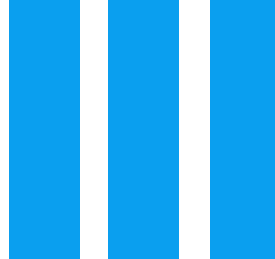

Suporte S

8 Unidades



Perfil H

2 Unidades

Disponível nos tamanhos

- 2,2 Metros
- 2,4 Metros
- 4,4 Metros
- 4,8 Metros



Fixador central

6 Unidades



Fixador Final

4 Unidades



Fixa técnica PES 0014



Suporte S



ARRUELA DE PRESSÃO M8 DIN 127 INOX

08 peças



PORCA SEXT M8 DIN 934 INOX

08 peças



PARAFUSO T M8X20 INOX

08 peças



ARRUELA DE VEDAÇÃO EDMP M5

08 peças



BORRACHA DE VEDAÇÃO EDMP

08 peças



PARAFUSO INOX M5 X 100MM

08 peças



Fixador Final



PARAFUSO CIL SX INT M6 X 40 DIN 912 INOX

04 peças



PORCA QUADRADA M6 DIN 557 INOX

04 peças



ARRUELA DE PRESSÃO M6 DIN 127 INOX

04 peças



Fixador Central



PARAFUSO CIL SX INT M6 X 40 DIN 912 INOX

06 peças



PORCA QUADRADA M6 DIN 557 INOX

06 peças



ARRUELA DE PRESSÃO M6 DIN 127 INOX

06 peças

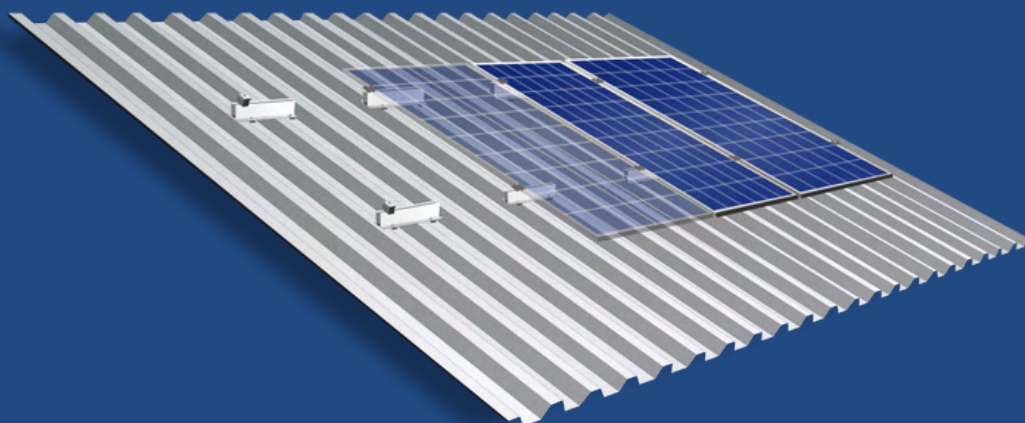

Kit fixação Mini Trilho

Código: PES 0020
PES 0022

Composição Kit fixação Mini Trilho PES 0022



Mini Trilho Alto

1 Unidade 100mm (altura) x 550mm (comprimento)



PARAFUSO SEXT. BROCANTE FLANGEADO 5.5X25 06 PEÇAS



BORRACHA DE VEDAÇÃO 06 PEÇAS

Itens necessários, adquiridos separadamente de acordo com o projeto a ser executado



Fixador central



Fixador Final

Composição Kit fixação Mini Trilho PES 0020



Mini Trilho Alto

1 Unidade 100mm (altura) x 300mm (comprimento)



PARAFUSO SEXT. BROCANTE FLANGEADO 5.5X25 06 PEÇAS



BORRACHA DE VEDAÇÃO 06 PEÇAS

Itens necessários, adquiridos separadamente de acordo com o projeto a ser executado



Fixador central



Fixador Final

Composição Kit Suporte Kalhetão PES 0026

PARAFUSO CIL SX INT M6 X 40 DIN 912 INOX

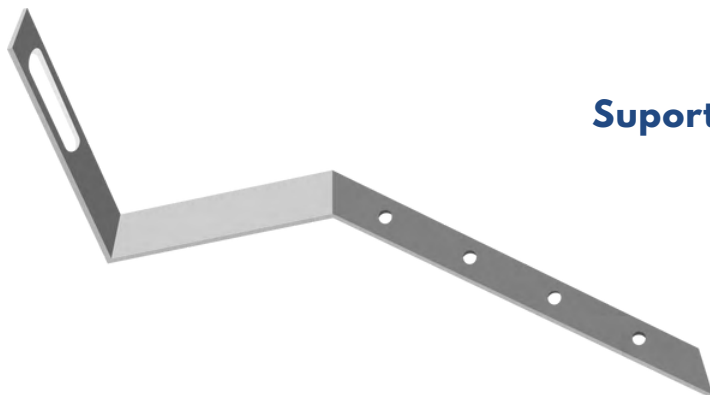

Suporte Kalhetão

8 Unidades



PARAFUSO T M8 X 20 INOX

08 peças



ARRUELAS DE PRESSÃO INOX M8

08 peças



PORCAS SEXTAVADAS M8 INOX

08 peças

**Itens necessários, adquiridos separadamente de
acordo com o projeto a ser executado**



Perfil H



**Fixador
central**



**Fixador
Final**



**Suporte de
solo para
4 módulos
PES 0023**

**Suporte de
solo para
8 módulos
PES 0031**

Os suportes do Kit Suporte de Solo são fabricados em aço SAE1008, recebem tratamento anticorrosivo, garantindo a qualidade e durabilidade dos produtos.

Suporte de solo para 4 módulos. PES 0023

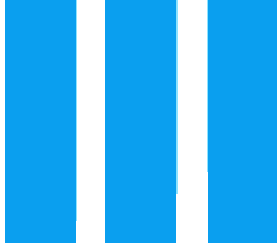

PES 0012 4 400mm
PES 0023 4800mm

30

**ITENS NECESSÁRIOS, ADQUIRIDOS SEPARADAMENTE DE
ACORDO COM O PROJETO A SER EXECUTADO**



**Fixador
central**
PES 0016



**Fixador
Final**
PES 0017

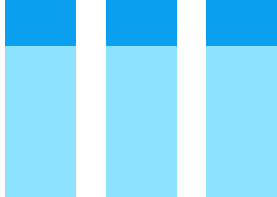

41

Suporte de solo para 8 módulos. PES 0031



PES 0031

**ITENS NECESSÁRIOS, ADQUIRIDOS SEPARADAMENTE DE
ACORDO COM O PROJETO A SER EXECUTADO**



**Fixador
central
PES 0016**



**Fixador
Final
PES 0017**





**Suporte de laje
em alumínio para
4 módulos
PES 0013**



**Itens necessários, adquiridos separadamente de
acordo com o projeto a ser executado**



Perfil H



**Fixador
central**



**Fixador
Final**

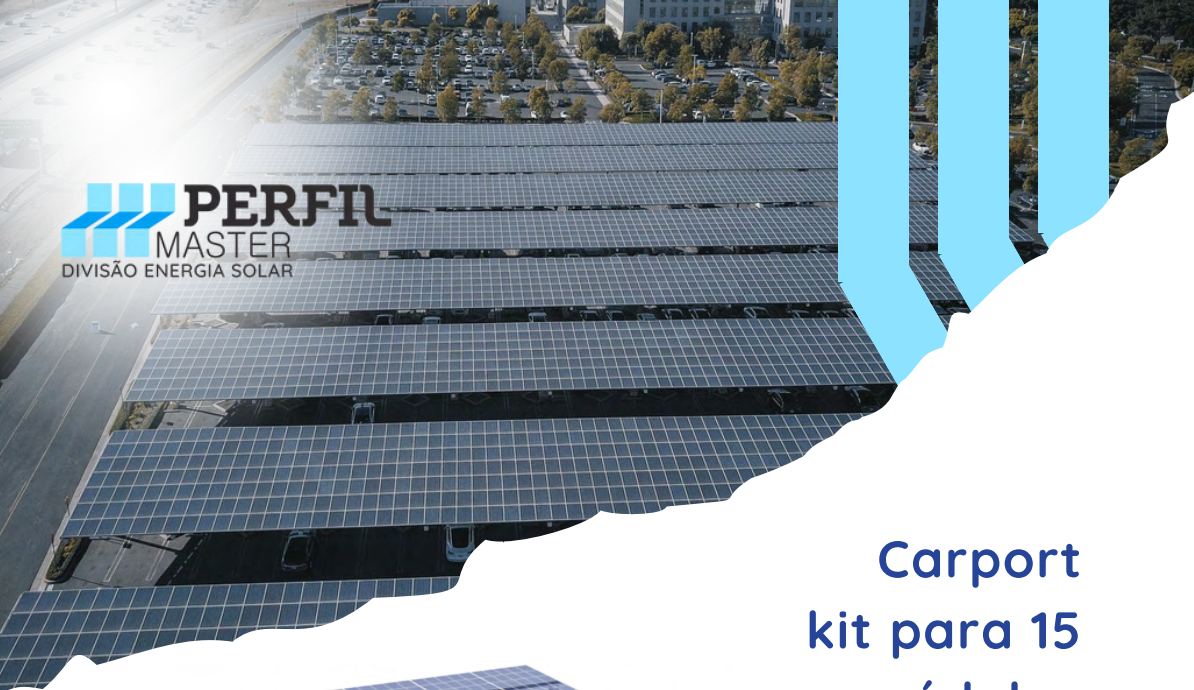

Carport kit para 15 módulos

Código: PES 0028
5.900mm X 6.900mm

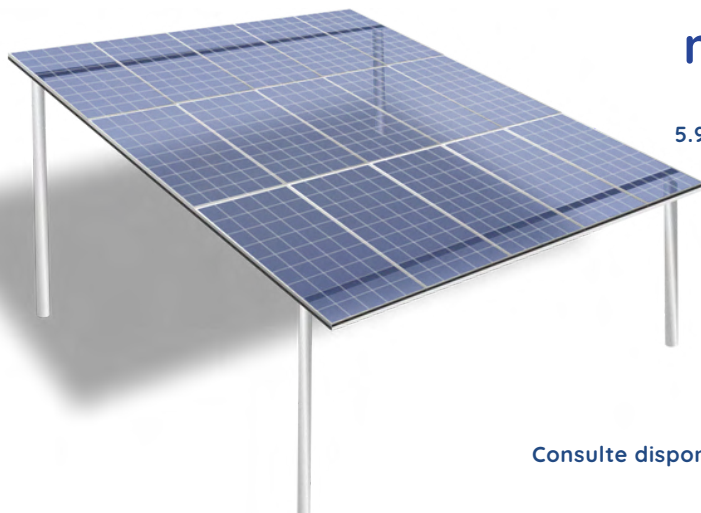

Consulte disponibilidade

**Itens necessários, adquiridos separadamente de
acordo com o projeto a ser executado**



**Fixador
central**



**Fixador
Final**

Os suportes do Carport são fabricados em aço SAE1008, recebem tratamento anticorrosivo, garantindo a qualidade e durabilidade dos produtos.



WWW.PERFILMASTER.COM.BR



11 91483-4040



11 4823-7008



divisao.solar@perfilmaster.com.br



Rodovia Índio Tibiriça, 10703 - Ipelândia - Suzano - SP - 08620-000



Perfil Master Energia Solar



perfil_master_des