



User manual

Solar Grid-tied Inverter

Product Model: SOFAR 3K~6KTLM-G3



Contents

Preface.....	II
1. Basic safety information.....	- 1 -
1.1. Safety instructions.....	- 1 -
1.2. Symbols and signs.....	- 4 -
2. Product characteristics.....	- 6 -
2.1. Product dimensions.....	- 6 -
2.2. Function characteristics.....	- 8 -
2.3. Efficiency curve.....	- 10 -
3. Installation.....	- 11 -
3.1. Installation Process.....	- 11 -
3.2. Checking Before Installation.....	- 11 -
3.3. Tools.....	- 14 -
3.4. Determining the Installation Position.....	- 15 -
3.5. Moving the SOFAR 3K~6KTLM-G3.....	- 17 -
3.6. Installing SOFAR 3K~6KTLM-G3.....	- 18 -
4. Electrical Connections.....	- 19 -
4.1. Outlines of this chapter.....	- 19 -
4.2. Connecting PGND Cables.....	- 20 -
4.3. Connecting DC Input Power Cables.....	- 22 -
4.4. Connecting AC Output Power Cables.....	- 24 -
4.5. Com port connection.....	- 28 -
4.6. WIFI/GPRS.....	- 36 -
5. Commissioning of inverter.....	- 38 -
5.1. Safety inspection before commissioning.....	- 38 -
5.2. Start inverter.....	- 38 -
5.3. Shutdown inverter.....	- 39 -
5.4. Setting power quality response modes.....	- 39 -
6. Operation interface.....	- 40 -
6.1. Operation and Display Panel.....	- 40 -
6.2. Standard Interface.....	- 41 -
6.3. Main Interface.....	- 43 -
6.4. Update Software online.....	- 51 -
7. Trouble shooting.....	- 52 -
7.1. Trouble shooting.....	- 52 -
7.2. Maintenance.....	- 59 -
8. Technical data.....	- 60 -
8.1. Input parameters (DC).....	- 60 -
8.2. Output parameters (AC).....	- 61 -
8.3. Efficiency,Protection and Communication.....	- 62 -
8.4. General Date.....	- 63 -
9. Quality Assurance.....	- 64 -

Notice

This manual contains important safety instructions that must be followed during installation and maintenance of the equipment.

Save these instructions!

This manual must be considered as an integral part of the equipment. The manual must always accompany the equipment, even when it is transferred to another user or field.

Copyright Declaration

The copyright of this manual belongs to Shenzhen SOFARSOLAR Co. Ltd. Any corporation or individual should not plagiarise, partially copy or fully copy it (including software, ect),and no reproduction or distribution of it in any form or by any means. All right reserved.

SOFARSOLAR reserves the right of final interpretation. This manual is subject to change according to user's or customer's feedback. Please check our website at <http://www.sofarsolar.com> for latest version.

The current Version updated at 20210812.

The current Version is V1.01

Preface

Outline

Please read the product manual carefully prior to installation, operation or maintenance. This manual contains important safety instructions and installation instructions that must be followed during installation and maintenance of the equipment.

Scope

This product manual describes the installation, electrical connections, commissioning, maintenance and troubleshooting of SOFAR 3K~6KTLM-G3 inverters:

3KTLM-G3	3.6KTLM-G3
4KTLM-G3	4.6KTLM-G3
5KTLM-G3	5KTLM-G3-A
6KTLM-G3	





Keep this manual where it will be accessible at all times.

Target Group

This manual is intended for qualified electrical technical personnel who are responsible for inverter installation and commissioning in the PV power system and PV plant operator.

Symbols Used

This manual is providing safety operation information and uses the symbol in order to ensure personal and property security and use inverter efficiently when operating the inverter. You must understand these emphasized information to avoid any personal injury and property loss. Please read the following symbols used in this manual carefully.

 Danger	Danger indicates a hazardous situation which, if not avoided, will result in death or serious injury.
 Warning	Warning indicates a hazardous situation which, if not avoided, could result in death or serious injury.
 Caution	Caution indicates a hazardous situation which, if not avoided, could result in minor or moderate injury.
 Attention	Attention indicates potential risks which, if not avoided, may lead to equipment fault or property damage.
 Note	Note provides tips that are valuable for the optimal operation of the product.

1. Basic safety information



Note

If you have any question or problem when you read the following information, please contact Shenzhen SOFARSOLAR Co. Ltd.

Outlines of this chapter

Safety instruction

Introduce the safety instruction when install and operate the equipment.

Symbols and signs

Introduce the safety symbols on the inverter.

1.1. Safety instructions

Read and understand the instructions of this manual and be familiar with relevant safety symbols in this chapter, prior to installing and troubleshooting the equipment.

Prior to connecting the inverter to the grid, please contact the local distribution network service provider permission in accordance to the national and state requirements. This can only be performed by qualified electrical engineer/electrician.

Please contact the nearest authorized service centre if any maintenance or repair is needed. Contact your distributor for the information of the nearest authorized service centre. Do NOT attempt to repair it by yourself, it may cause injury or property damage.

Before installing and maintaining the equipment, turn the DC switch isolators OFF to cut off the high voltage DC from the PV array. You can also turn the switch in the PV combiner box OFF to cut off the high voltage DC to prevent serious injuries or damage to property.

Target Audience

Staff in charge of using and maintaining the equipment must be trained, aware and mature for the described tasks and must have the reliability to correctly interpret what is described in the manual. For safety reason, only a qualified electrician, who has received training and/or has demonstrated skills and knowledge in construction and in operation of this unit, can install this inverter. Shenzhen SOFARSOLAR Co. Ltd does not take any responsibility for the property destruction and personal injury because of any misuse.

Installation requirements

Please install inverter according to the following section. Fix the inverter on an appropriate object with enough load bearing capacity (such as walls, PV racks etc.), and ensure that inverter is vertical placed. Choose a place suitable for installing electrical devices. And assure there is enough fire exit space, convenient for maintenance. Maintain proper ventilation to ensure enough air cycle to cool the inverter.

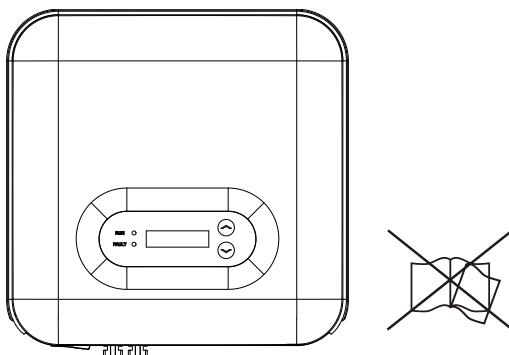

Transport requirements





If you find packing problems that may cause the damage of the inverter, or find any visible damage, please immediately notice the responsible transportation company. You can ask solar equipment installation contractor or Shenzhen SOFARSOLAR Co. Ltd. for help if necessary.

Transport of the equipment, especially by road, must be carried out with by



suitable ways and means for protecting the components (in particular, the electronic components) from violent shocks, humidity, vibration, etc.

Electric connection



Please comply with all the current electrical regulations about accident prevention in dealing with the solar invert.

 Danger	<p>Before the electrical connection, make sure to use opaque material to cover the PV modules or to disconnect PV array DC switch. Exposure to the sun, PV array will produce a dangerous voltage!</p>
 Warning	<p>All installation accomplished only by professional electrical engineer! Must be trained; Completely read the manual operation and understand relevant matter.</p>
 Attention	<p>Get permission from the local electrical grid operator, complete all electrical connections by professional electrical engineer, then connect inverter to electrical grid.</p>
 Note	<p>It's forbidden to remove the tamper evident label, or open the inverter. Otherwise Sofarsolar will not provide warranty or maintenance!</p>

Operation

 Danger	<p>Touching the electrical grid or the terminal of the equipment may lead to electrocution or fire! Don't touch the terminal or conductor connected to the electrical grid. Pay attention to any instructions or safety documents related to grid connection.</p>
 Attention	<p>Some internal components will be very hot when inverter is working. Please wear protective gloves! Keep it away from kids!</p>

Maintenance and repair



	<p>Before any repair work, turn OFF the AC circuit breaker between the inverter and electrical grid first, then turn OFF the DC switch. After turning OFF the AC circuit breaker and DC switch, wait for 5 minutes at least before carrying out any maintenance or repair work.</p>
Danger	
	<p>Inverter should work again after removing any faults. If you need any repair work, please contact with the local authorized service center. Can't open the internal components of inverter without authorized. Shenzhen SOFARSOLAR Co. Ltd. does not take any responsibility for the losses from that.</p>
Attention	

EMC / noise level of inverter

Electromagnetic compatibility (EMC) refers to an electrical equipment functions in a given electromagnetic environment without any trouble or error, and impose no unacceptable effect upon the environment. Therefore, EMC represents the quality characters of an electrical equipment. The inherent noise-immune character: immunity to internal electrical noise. External noise immunity: immunity to electromagnetic noise of external system. Noise emission level: influence of electromagnetic emission upon environment.









	<p>Electromagnetic radiation from inverter may be harmful to health! Please do not continue to stay around the inverter in less than 20 cm when inverter is working.</p>
Danger	

1.2. Symbols and signs

	<p>Caution of burn injuries due to hot enclosure! You can only touch the screen and pressing key of the inverter while it's working.</p>
Caution	
	<p>PV array should be grounded in accordance to the requirements of the local electrical grid operator! We suggest that all PV module frames and inverter are reliably grounded to protect the PV system and personnel security.</p>
Attention	
	<p>Ensure input DC voltage < Max. DC voltage .Over voltage may cause permanent damage to inverter or other losses, which will not be included in warranty!</p>
Warning	

Signs on the inverter

There are some symbols which are related to security on the inverter. Please read and understand the content of the symbols, and then start the installation.

	There is a residual voltage in the inverter! Before opening the equipment, operator should wait for five minutes to ensure the capacitor is discharged completely.
	Caution, risk of electric shock.
	Caution hot surface.
	Comply with the Conformance Européenne (CE) certification.
	Grounding point.
	Please read this manual before install SOFAR 3K~6KTLM-G3.
	This indicates the degree of protection of the equipment according to IEC standard 70-1 (EN 60529 June 1997).
	Positive pole and negative pole of the input voltage (DC).
	RCM (Regulatory Compliance Mark) The product complies with the requirements of the applicable Australian standards.

2. Product characteristics

Outline of this chapter

Product dimensions

It introduces the field of use, and the overall dimensions of SOFAR 3K~6KTLM-G3 inverters.

Function description

It introduces how SOFAR 3K~6KTLM-G3 inverters work and the function modules inside.

Efficiency curves

It introduces the efficiency curves of in the inverter.

2.1. Product dimensions

SOFAR 3K~6KTLM-G3 is a dual MPPT grid-tied PV inverter which converts the DC power generated by PV arrays into sine wave single-phase AC power and feeds it to the public electrical grid, AC circuit breaker (refer to Section 4.4) and DC switch used as disconnect device, and the disconnect device shall be easily accessible.

Figure2-1 PV Grid-tied System

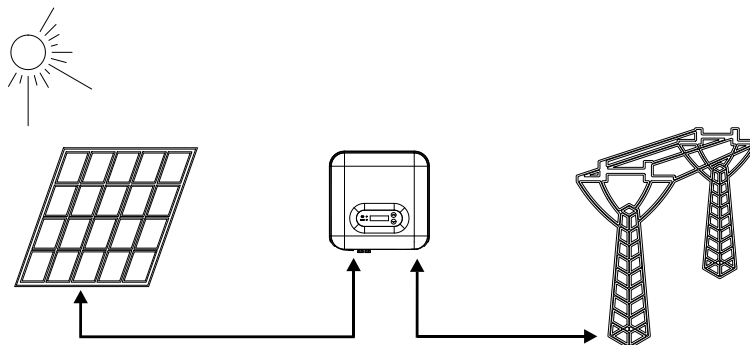

SOFAR 3K~6KTLM-G3 inverters can only be used with photovoltaic modules

that do not require one of the poles to be grounded. The operating current during normal operation must not exceed the limits specified in the technical specifications. Only the photovoltaic modules can be connected to the input of the inverter (do not connect batteries or other sources of power supply).

The choice of optional parts of inverter should be made by a qualified technician who knows the installation conditions clearly.

Overall dimensions: $L \times W \times H = 349\text{mm} \times 344\text{mm} \times 164\text{mm}$

Figure 2-2 Front view and left view dimensions of SOFAR 3K~6KTLM-G3

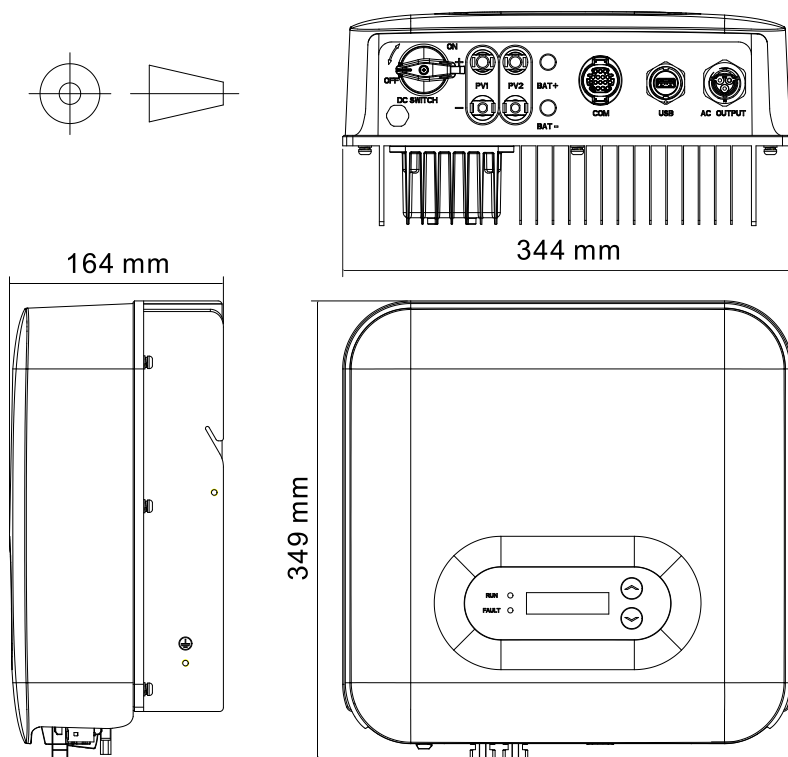
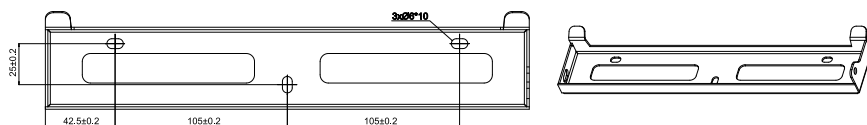

Figure 2-3 Bracket dimensions of SOFAR 3K~6KTL-G3



◆ Labels on the equipment



The labels must NOT be covered by objects and/or parts (boxes, equipment, etc.); they must be cleaned regularly and kept visible at all times.

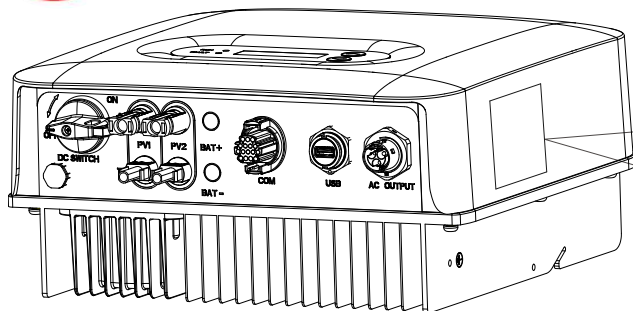

SOFAR Solar Grid-tied Inverter	
Model No.	SOFAR 6KTLM-G3
Max. DC Input Voltage	850V
Operating/MPPPT Voltage Range	80-550V
Max. Input Current	24.15A
Max. DC Input Power	20325W
Nominal Grid Voltage	220V/230V
Nominal Output Current	22.3A
Max. Output Current	29A
Nominal Grid Frequency	50/60Hz
Nominal Output Power	6000W
Rated Output Power	6000VA
Max. Output Power	6000VA
Power Factor	1 (adjustable +0.8)
Ingress Protection	IP20
Operating Temperature Range	-20°C~50°C
Protective Class	Class I
Inverter Topology	Non Isolated
Overvoltage Category	AC III, GCI1
Manufacturer: Shenzhen SOFARSOLAR Co., Ltd. Address: 401 Building, An Digital Industrial Park, District 58, Xunfeng Community, Xixiang Street, Bao'an District, Shenzhen, China VCE0126-1-039-AS4777 ISO9001:2015/IEC62319:2014	

2.2. Function characteristics

DC power generated by PV array is filtered through input board before entering the power board. Input Board also offer functions such as insulation impedance detection and input DC voltage / current detection. DC power is converted to AC power by Power Board. AC power is filtered through Output Board then AC power is fed into the grid. Output Board also offer functions such as grid voltage / output current detection, GFCI and output isolation relay. Control Board provides the auxiliary power, controls the operation state of inverter and shows the operation status by Display Board. Display Board displays fault code when inverter is in abnormal operation conditions. At the same time, Control Board can trigger the relay to protect the internal components.

Function module

A. Energy management unit

This control can be used to switch the inverter on/off through an external (remote) control.

B. Feeding reactive power into the grid

The inverter is able to produce reactive power and can therefore feed it into the grid through the setting of the phase shift factor. Feed-in management can be controlled directly by the grid company through a dedicated RS485 serial interface.

C. Limiting the active power fed into the grid

The inverter, if enabled can limit the amount of active power fed into the grid by the inverter to the desired value (Expressed as a percentage).

D. Self power reduction when grid is over frequency

When the grid frequency is higher than the limited value, inverter will reduce output power which is necessary for the grid stability.

E. Data transmission

The inverter or a group of inverters may be monitored remotely through an advanced communication system based on RS-485 serial interface, or remotely via the WIFI/GPRS.

F. Software update

Support USB flash drive local upgrade software and WIFI/GPRS remote upgrade software.

Electrical block diagram

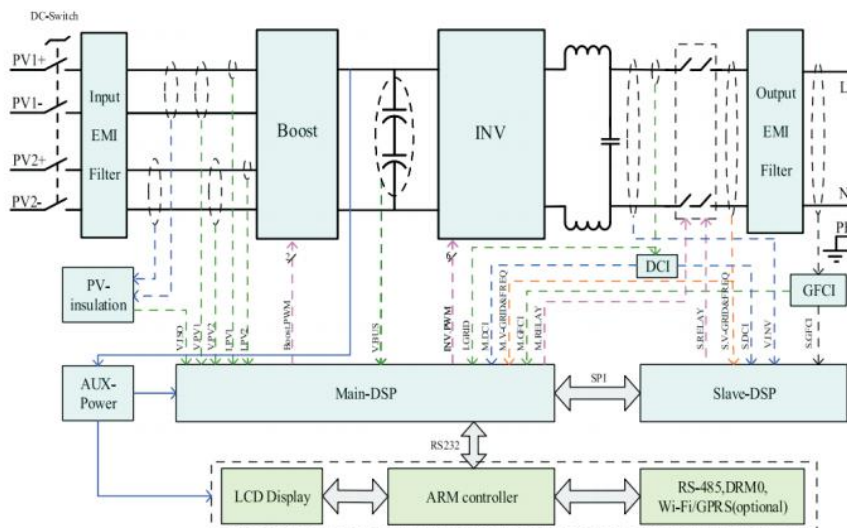

Figure2-4 Electrical block diagram

2.3. Efficiency curve

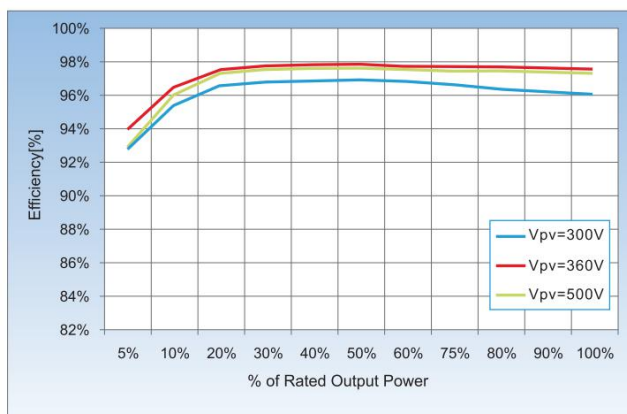





Figure2-5 Efficiency Curve diagram

3. Installation

Outlines of this chapter

This topic describes how to install the SOFAR 3K~6KTLM-G3 .

Installation notes

 Danger	Do NOT install the SOFAR 3K~6KTLM-G3 on flammable material. Do NOT install the SOFAR 3K~6KTLM-G3 in an area used to store Flammable or explosive material.
 Caution	The enclosure and heat sink are very hot while the inverter is working, therefore do NOT install the SOFAR 3K~6KTLM-G3 in places where you might touch them inadvertently.
 Attention	Consider the weight of SOFAR 3K~6KTLM-G3 when transporting and moving the inverters. Choose an appropriate mounting position and surface. Assign at least two persons to install the inverter.

3.1. Installation Process

Figure 3-1 Installation flowchart

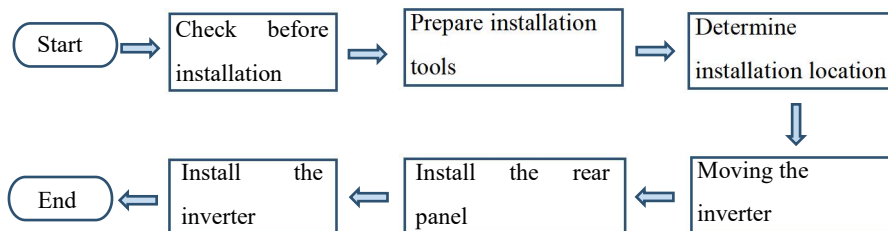

3.2. Checking Before Installation

Checking Outer Packing Materials



Packing materials and components may be damaged during transportation.



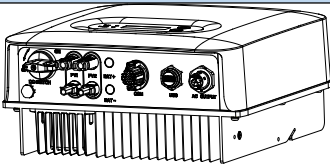
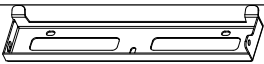
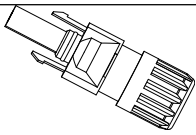
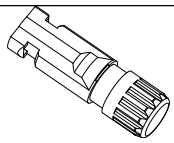

Therefore, check the outer packing materials before installing the inverter. Check the outer packing materials for damage, such as holes and cracks. If any damage is found, do not unpack the SOFAR 3K~6KTLM-G3 and contact the dealer as soon as possible. You are advised to remove the packing materials within 24 hours before installing the SOFAR 3K~6KTLM-G3 inverter.

Checking Deliverables

After unpacking the inverter, check whether deliverables are intact and complete. If any damage is found or any component is missing, contact the dealer.

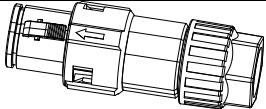
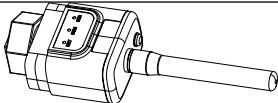
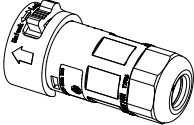
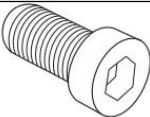
Table 3-1 Shows the components and mechanical parts that should be delivered.

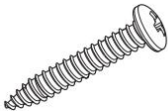

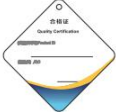



NO.	Picture	Description	Quantity
1		3K~6KTLM-G3	1pcs
2		Rear panel	1pcs
3		PV+ input terminal	2pcs
4		PV- input terminal	2pcs
5		Metal terminals secured to PV+ input power cables	2pcs
6		Metal terminals secured to PV- input power cables	2pcs

7		COM 16pin Communication Terminal	1pcs
8		USB logger (WIFI/GPRS/Ethernet)	1pcs (Optional)
9		AC output terminal	1pcs
10		M6 Hexagon screws	2pcs
11		Expansion bolts	3pcs
12		Self-tapping screw	3pcs
13		Manual	1pcs
14		The warranty card	1pcs
15		Registration Form	1pcs

3.3. Tools

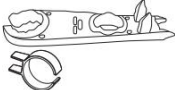
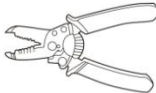
Prepare tools required for installation and electrical connections.

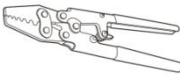
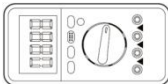
Table 3-2 Shows the tools required for installation and electrical connections.

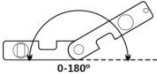
NO.	Tool	Model	Function
1		Hammer drill Recommend drill dia. 6mm	Used to drill holes on the wall.
2		Screwdriver	Wiring
3		Cross screwdriver	Remove and install AC terminal screws
4		Removal tool	Remove PV terminal
5		Wire stripper	Strip wire
6		5mm Allen Wrench	Turn the screw to connect rear panel with inverter.
7		Crimping tool	Used to crimp power cables
8		Multimeter	Used to check grounding
9		Marker	Used to mark signs
10		Measuring tape	Used to measure distances
11		Level	Used to ensure that the rear panel is properly installed

12		ESD gloves	Operators wear
13		Safety goggles	Operators wear
14		Anti-dust respirator	Operators wear

3.4. Determining the Installation Position

Determine an appropriate position for installing the SOFAR 3K~6KTLM-G3 inverter. Comply with the following requirements when determining the installation position:

Figure 3-2 Installation Requirements

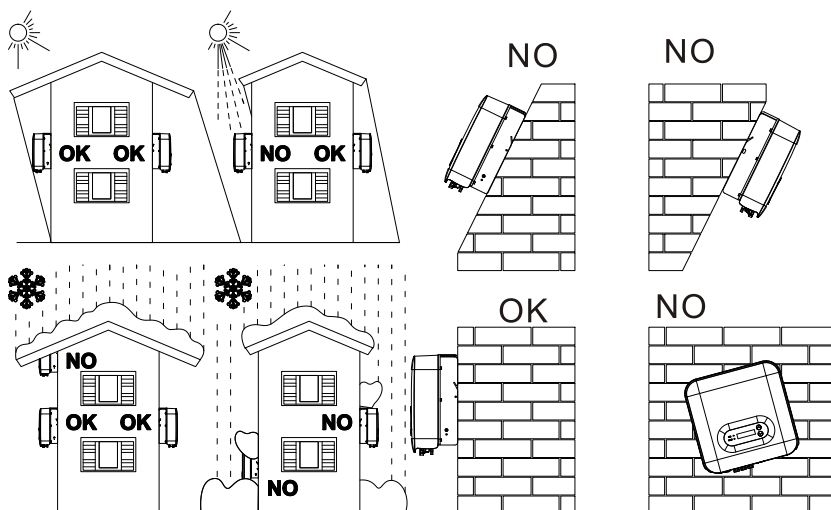

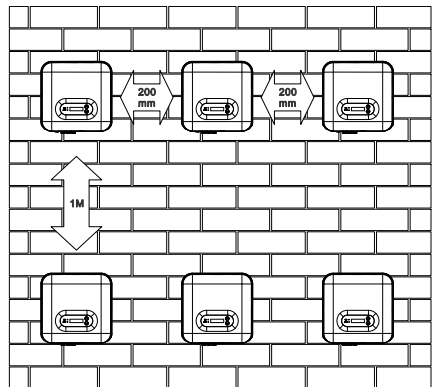
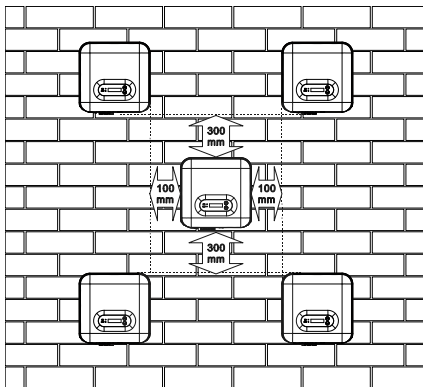
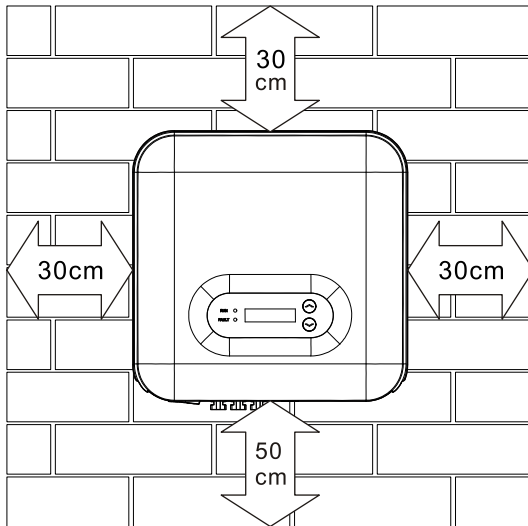
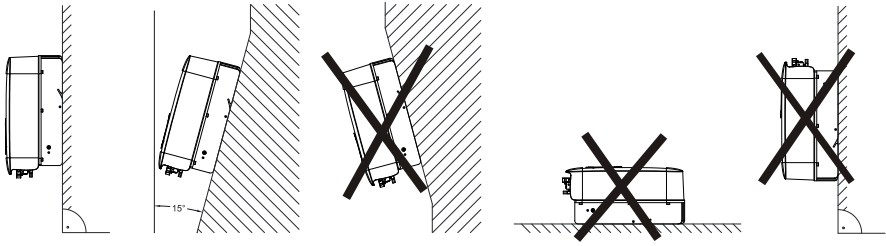

3.5. Moving the SOFAR 3K~6KTLM-G3

This topic describes how to move the to the installation position Horizontally SOFAR 3K~6KTLM-G3.

Step 1 Open the packaging, insert hands into the slots on both sides of the inverter and hold the handles, as shown in Figure 3-3 and Figure 3-4.

Figure 3-3 Moving the inverter (1)

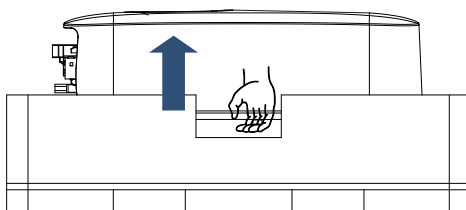
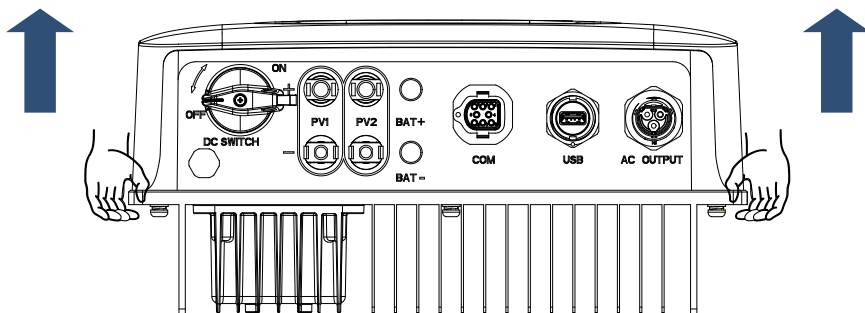

Figure 3-4 Moving the inverter (2)



Step 2 Lift the SOFAR 3K~6KTLM-G3 from the packing case and move it to the installation position.



Attention

To prevent device damage and personal injury, keep balance when moving the inverter because the inverter is heavy.
Do not put the inverter with its wiring terminals contacting the floor because the power ports and signal ports are not designed to support the weight of the inverter. Place the inverter horizontally.
When placing the inverter on the floor, put foam or paper under the inverter to protect its shell.

3.6. Installing SOFAR 3K~6KTLM-G3

Step 1 Determine the positions for drilling holes, ensure the hole positions are level, then mark the hole positions using a marker pen, use the hammer drill to drill holes on the wall. Keep the hammer drill perpendicular to the wall, do not shake when drilling, so as not to damage the wall. If the error of the hole positions is too big, you need to reposition.

Step 2 Insert the expansion bolt vertically into the hole, pay attention to the insertion depth of the expanding bolt (should be deep enough).

Step 3 Align the rear panel with hole positions, fix the rear panel on the wall by tightening the expansion bolt with the nuts. (Torque: 16kgf.cm)

Figure 3-5

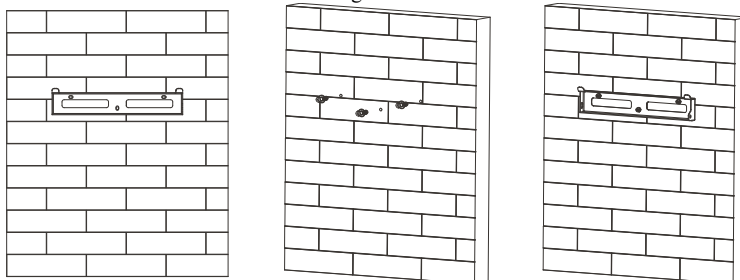

Step 4 Hook the inverter to the rear panel. Using an M6 screw to secure the inverter to the rear panel to ensure safety. (Torque: 25kgf.cm)

Step 5 You can secure the inverter to the rear panel and protect it from stealing by installing an anti-theft lock (this action is optional).

Figure 3-6

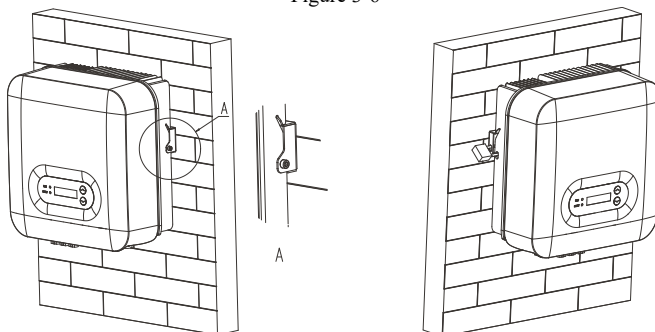



4. Electrical Connections

4.1. Outlines of this chapter

This topic describes the SOFAR 3K~6KTLM-G3 inverter electrical connections. Read this part carefully before connecting cables.

NOTE: Before performing electrical connections, ensure that the DC switch is OFF. Since the stored electrical charge remains in a capacitor after the DC switch is turned OFF. So it's necessary to wait for at least 5 minutes for the capacitor to be electrically discharged.

	Installation and maintenance of inverter, must be operated by professional electrical engineer.
Attention	
	PV modules generate electric energy when exposed to sunlight and can create an electrical shock hazard. Therefore, before connecting DC input power cable, cover PV modules using opaque clot
Danger	
	For SOFAR 3K~6KTLM-G3, open-circuit voltage(Voc) of module arrays connected in series must be $\leq 550V$.
Note	

The connected PV modules must have an IEC 61730 Class A rating

IscPV(absolute maximum)	22.5A/22.5A	
Maximum output over current protection	SOFAR 3KTLM-G3	15A
	SOFAR 3.6KTLM-G3	16A
	SOFAR 4KTLM-G3	20A
	SOFAR 4.6KTLM-G3	23A
	SOFAR 5KTLM-G3	25A
	SOFAR 5KTLM-G3-A	21.7A
	SOFAR 6KTLM-G3	29A

The decisive voltage class(DVC)

NOTE:The DVC is the voltage of a circuit which occurs continuously between any two

live part in the worst-case rated operating condition when used as intended.

Interface	DVC
PV input interface	DVCC
AC output interface	DVCC
USB interface	DVCA
Com interface	DVCA

DC switch parameters

Rated-insulation voltage	1100V
Rated impulse withstand voltage	8KV
Rated operational current (Ie)	1100V/5A, 1000V/8A, 800V/12.5A, 500V/25A
PV utilization category	DC-PV2
Rated short time withstand current (Icw)	700A
Rated short-circuit making capacity (Icm)	4xIe
Rated breaking capacity	4xIe

PV terminal parameters

Rated-insulation voltage	1000V
Rated operational current	39A
Protection class	IP68
Maximum temperature limit	105°C

4.2. Connecting PGND Cables

Connect the inverter to the grounding electrode using protection ground (PGND) cables for grounding purpose.

	<p>The inverter is transformer-less, requires the positive pole and negative pole of the PV array are NOT grounded. Otherwise it will cause inverter failure. In the PV power system, all non current carrying metal parts (such as: PV module frame, PV rack, combiner box enclosure, inverter enclosure) should be connected to earth.</p>
Attention	

Prerequisites:

The PGND cables are prepared ($\geq 4\text{mm}^2$ outdoor power cables are recommended for grounding purposes), the color of cable should be yellow-green.

Procedure:

Step 1 Remove the insulation layer with an appropriate length using a wire stripper, as shown in Figure 4-1.

Figure4-1 Preparing a ground cable (1)

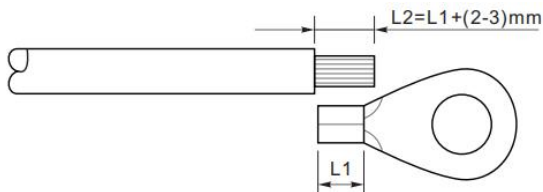

Note: L2 is 2 to 3mm longer than L1

Step 2 Insert the exposed core wires into the OT terminal and crimp them by using a crimping tool, as shown in Figure 4-2.

Figure4-2 Preparing a ground cable (2)

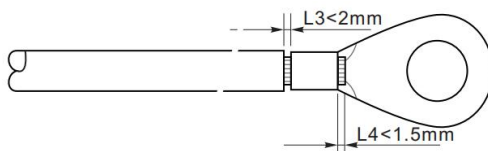

Note 1: L3 is the length between the insulation layer of the ground cable and the crimped part. L4 is the distance between the crimped part and core wires protruding from the crimped part.

Note 2: The cavity formed after crimping the conductor crimp strip shall wrap the core wires completely. The core wires shall contact the terminal closely.

Step 3 Install the crimped OT terminal, flat washer using M5 screw, and tighten the screw to a torque of 3 N.m using an Allen wrench.(Torque: 25kgf.cm)

Figure4-3 Ground terminal composition

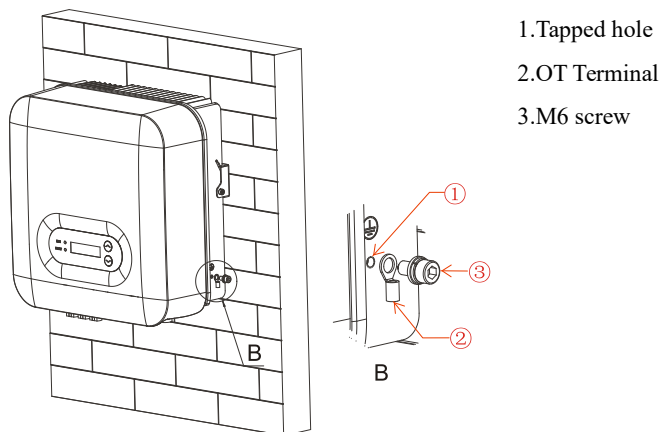

4.3. Connecting DC Input Power Cables

Table 4-1 Recommended DC input cable specifications

Cross-Sectional Area (mm ²)		External Cable Diameter(mm)
Range	Recommended Value	
4.0~6.0	4.0	4.5~7.8

Step 1 Remove cable glands from the positive and negative connectors.

Step 2 Remove the insulation layer with an appropriate length from the positive and negative power cables by using a wire stripper as show in Figure 4-4.

Figure 4-4 Connecting DC input power cables

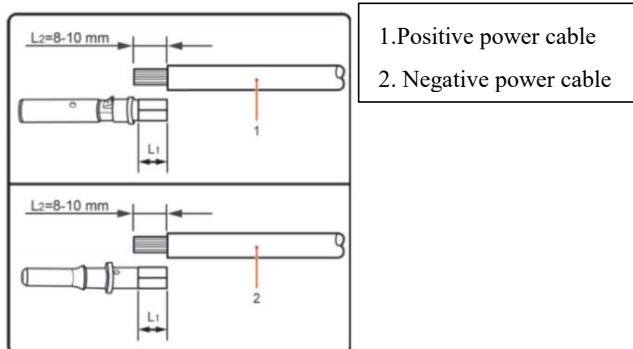

Note: L2 is 2 to 3 mm longer than L1.

Step 3 Insert the positive and negative power cables into corresponding cable glands.

Step 4 Insert the stripped positive and negative power cables into the positive and negative metal terminals respectively and crimp them using a crimping tool. Ensure that the cables are crimped until they cannot be pulled out by force less than 400 N, as shown in Figure 4-5.

Figure 4-5 Connecting DC input power cables

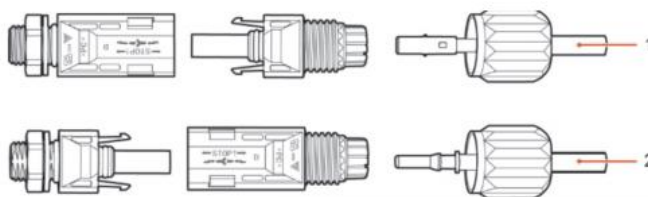

1.Positive power cable 2.Negative power cable

Step 5 Insert crimped power cables into corresponding housings until you hear a "click" sound. The power cables snap into place.

Step 6 Reinstall cable glands on positive and negative connectors and rotate them against the insulation covers.

Step 7 Insert the positive and negative connectors into corresponding DC input terminals of the inverter until you hear a "click" sound, as shown in Figure 4-6.

Figure 4-6 Connecting DC input power cables

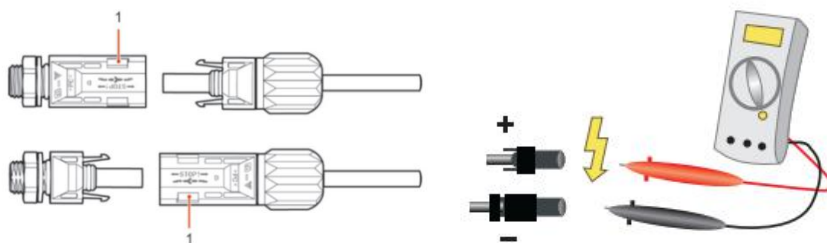

1.Bayonet

Note: Please use the multimeter to confirm the positive and negative poles of the photovoltaic array!

Follow-up Procedure

To remove the positive and negative connectors from the inverter, insert a removal wrench into the bayonet and press the wrench with an appropriate strength, as shown in Figure 4-7.



	Before removing the positive and negative connectors, ensure that the DC SWITCH is OFF.
Caution	

Figure 4-7 Removing a DC input connector

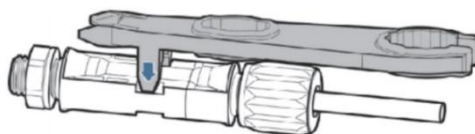

4.4. Connecting AC Output Power Cables

Connect the SOFAR 3K~6KTLM-G3 to the AC power distribution frame or power grid using AC output power cables.

	It is not allowed for several inverters to use the same circuit breaker. It is not allowed to connect loads between inverter and circuit breaker. AC breaker used as disconnect device, and the disconnect device shall remain readily operable.
Caution	

Context

SOFARSOLAR has already integrated RCMU (residual current monitoring unit) inside inverter, If an external RCD is required, a type-A RCD with rated residual current of 100mA or higher is suggested. Please check with the local regulation for the sizing of rated residual current.

All the AC output cables used for the inverters are outdoor three-core cables. To facilitate the installation, use flexible cables. Table 4-2 lists the recommended specifications for the cables.

Figure 4-8 NOT allowed: connect loads between inverter and circuit breaker

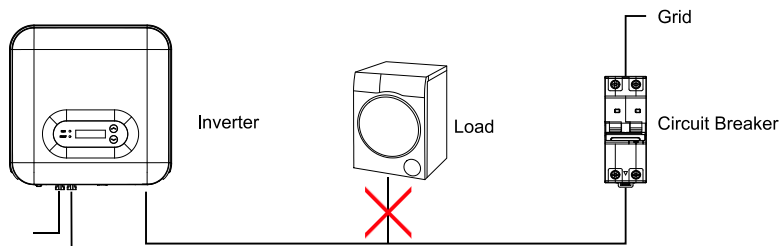
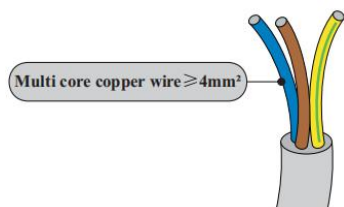

Table4-2 Recommended AC output cable sizing

Model	3KTLM-G3	3.6KTL-M-G3	4KTLM-G3	4.6KTLM-G3	5KTLM-G3	5KTLM-G3-A	6KTLM-G3
Cable (Copper)	≧6mm ²	≧6mm ²	≧6mm ²	≧10mm ²	≧10mm ²	≧10mm ²	≧10mm ²
Breaker	20A	25A	25A	32A	32A	32A	32A

Multi core copper wire



AC cable should be correctly sized to ensure the power loss in AC cable is less than 1% of the rated power. If the resistance of the AC cable is too high, it will cause a huge increase in the AC voltage, which may lead to a disconnection of the inverter from the electrical grid.

The relationship between power loss in AC cable and wire length, wire cross sectional area is shown in the following figure:

Figure 4-9 Wire length, wire cross sectional area and wire power loss

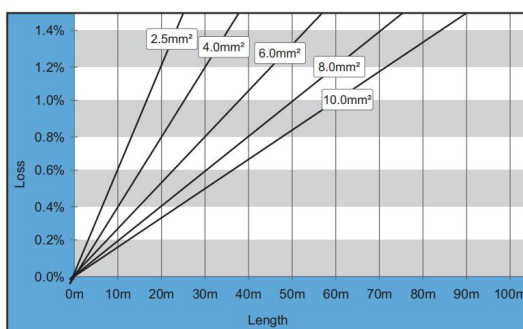

Inverter is equipped with IP66 AC connector, and the AC output cable needs to

be wired by the customer. The appearance of AC connector is shown in figure 4-10.

Figure 4-10 AC connector

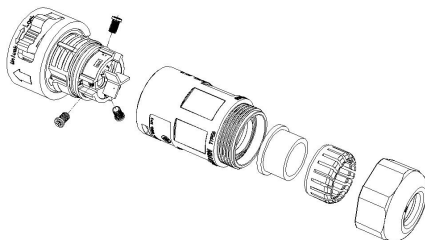

Step 1 Select appropriate cables according to Table 4-2, Remove the insulation layer of the AC output cable using a wire stripper according to the figure shown below: A:15-25mm B:6~8mm

Step 2 Disassemble the AC connector according to the figure shown below: insert the AC output cable (with its insulation layer stripped according to step 1) through the waterproof locking cable gland.

Step 3 Connect AC output cable as per the following requirements:

Connect the yellow-green wire to the hole labeled "PE", fasten the wire using an Cross screwdriver;

Connect the brown wire to the hole labeled "L", fasten the wire using an Cross screwdriver;

Connect the blue wire to the hole labeled "N", fasten the wire using an Cross screwdriver.

Step 4 Insert the AC connector and hear "click", then tighten the waterproof nut at the instantaneous value, as shown in the figure below, to ensure that the cable is firmly connected.

Figure 4-11

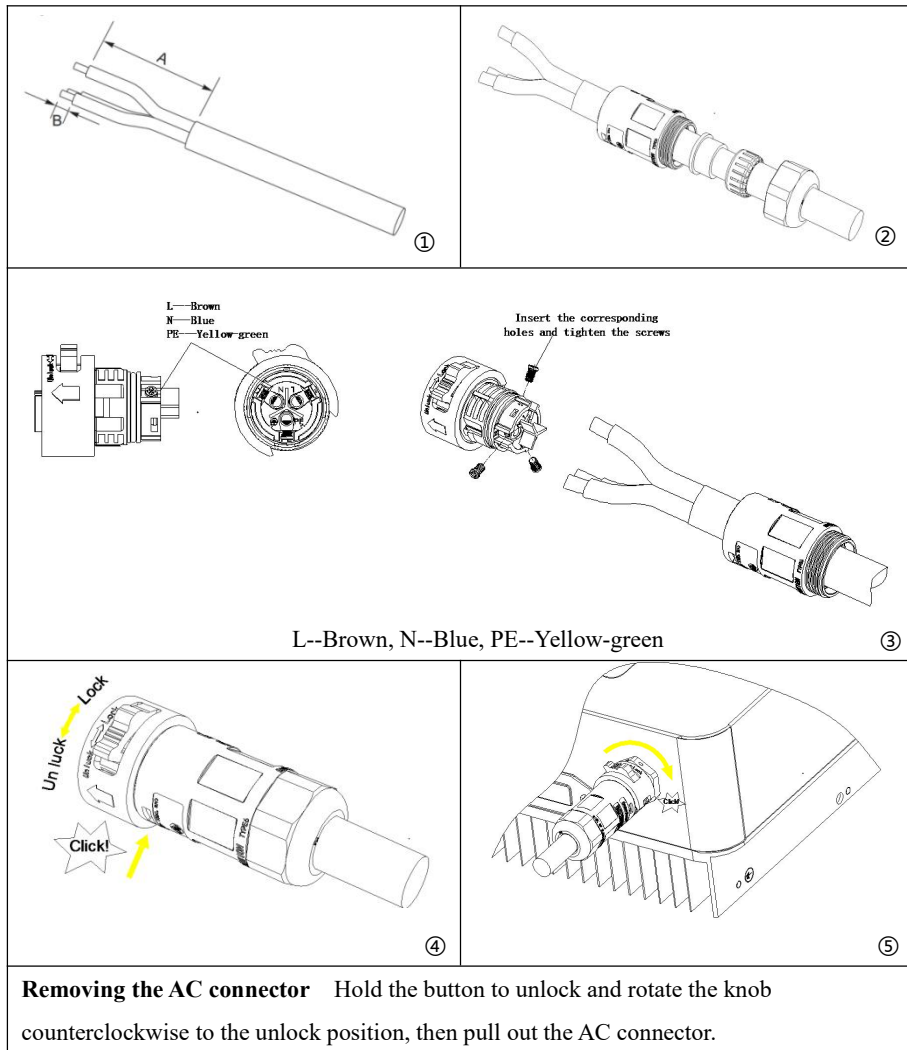

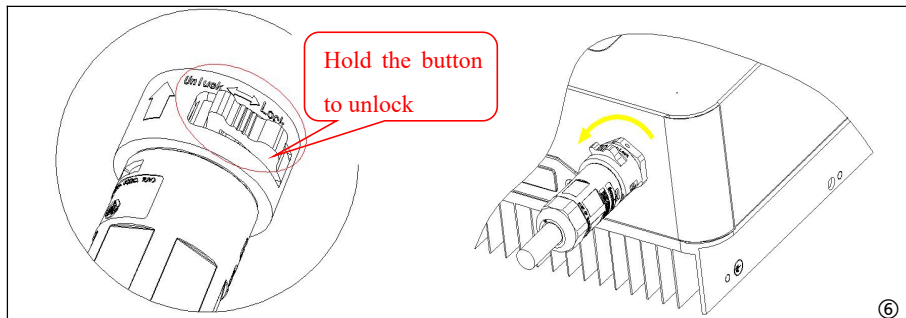
Caution

Make sure the grid is disconnected before removing the AC connector.

4.5. Com port connection

The com port location of the SOFAR 3K~6KTLM-G3 is shown in the figure below.

Figure 4-12 COM port appearance

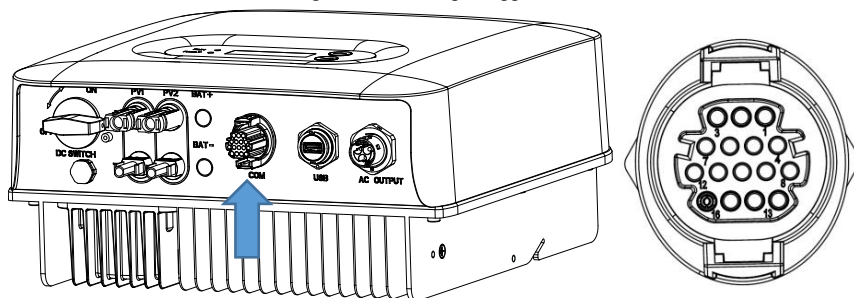
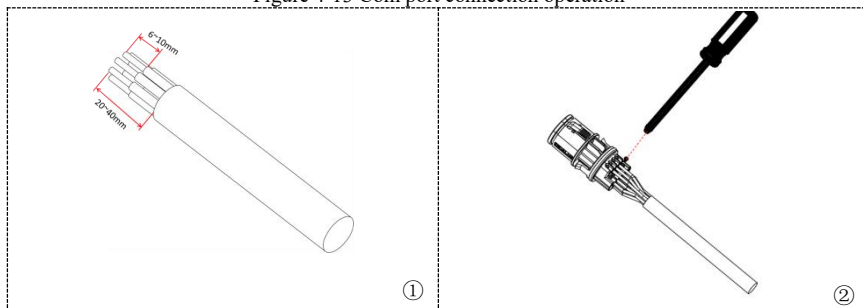

Table 4-3 Com port pin definitions

PIN	Definition	Function	Note
1	485_TX+	RS485 differential signal +	Wired monitoring or inverter cascade monitoring
2	485_TX+	RS485 differential signal +	
3	485_TX-	RS485 differential signal -	
4	485_TX-	RS485 differential signal -	Meter communication
5	RS485-A	RS485 differential signal +	
6	RS485-B	RS485 differential signal -	

7	GND.S	DRMS port logical IO	The logic interface pin definitions and circuit connections are so follows: Logic interface pin are defined according to different standard requirements
8	DRM0		
9	DRM1/5		
10	DRM2/6		
11	DRM3/7		
12	DRM4/8		
13	GND.S	Communication ground	
14	N/A	N/A	N/A
15	CT+	The current sensor outputs a positive electrode	Used to connect current sensor of power grid
16	CT-	The current sensor outputs a negative electrode	

Figure 4-13 Com port connection operation



4.5.1 Logic interface

(a) Logic interface for AS/NZS 4777.2:2020, also known as inverter demand response modes (DRMs).

The inverter will detect and initiate a response to all supported demand response commands within 2 s. The inverter will continue to respond while the mode remains asserted.

Table 4-3 Function description of the DRMs terminal

Pin NO.	Function
9	DRM1/5
10	DRM2/6
11	DRM3/7
12	DRM4/8
13	GND
8	DRM0

NOTE: Supported DRM command: DRM0, DRM5, DRM6, DRM7, DRM8.

(b) Logic interface for VDE-AR-N 4105:2018-11, is in order to control and/or limit the inverter's output power.

The inverter can be connected to a RRCR (Radio Ripple Control Receiver) in order to dynamically limit the output power of all the inverters in the installation.

Figure 4-14 Inverter – RRCR Connection

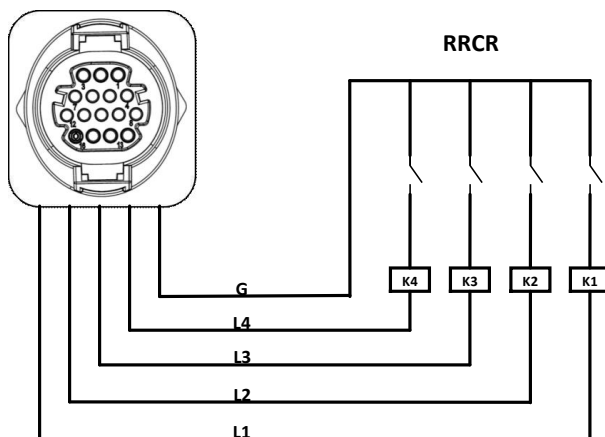

Table 4-4 Function description of the terminal

Pin NO.	Pin name	Description	Connected to (RRCR)
9	L1	Relay contact 1 input	K1 - Relay 1 output
10	L2	Relay contact 2 input	K2 - Relay 2 output
11	L3	Relay contact 3 input	K3 - Relay 3 output
12	L4	Relay contact 4 input	K4 - Relay 4 output
13	G	GND	Relays common node

Table 4-5 The inverter is preconfigured to the following RRCR power levels

Relay status: close is 1, open is 0

L1	L2	L3	L4	Active Power	cos(φ)
1	0	0	0	0%	1
0	1	0	0	30%	1
0	0	1	0	60%	1
0	0	0	1	100%	1

(c) Logic interface for EN50549-1:2019, is in order to cease active power output within five seconds following an instruction being received at the input interface.

Figure 4-15 Inverter – RRCR Connection

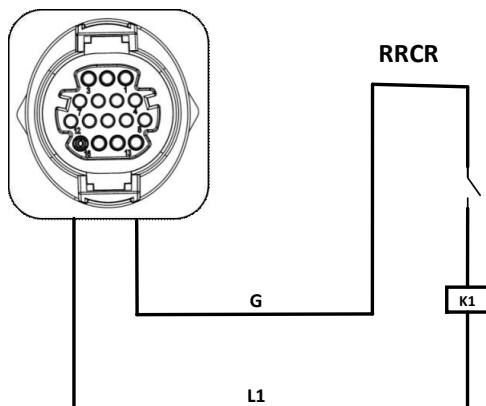

Table 4-6 Function description of the terminal

Pin NO.	Pin name	Description	Connected to (RRCR)
9	L1	Relay contact 1 input	K1 - Relay 1 output
13	G	GND	K1 - Relay 1 output

Table 4-7 The inverter is preconfigured to the following RRCR power levels.

Relay status: close is 1, open is 0

L1	Active Power	Power drop rate	Cos(φ)
1	0%	<5 seconds	1
0	100%	/	1

Step4 Insert the terminal as per the printed label, and then tighten the screws to fix the waterproof cover, rotate the cable gland clockwise to fasten it securely.

4.5.2 RS485 interface

By RS485 interface, transfer the inverter power output information, alarm information, operation state to the PC terminal or local data acquisition device, then uploaded to the server.

If only one SOFAR 3K~6KTLM-G3 is used, use a communication cable, refer to section 4.5.2 for COM pin definition, and select RS485 port to connect.

Figure 4-16 A single SOFAR 3K~6KTLM-G3 connecting communications

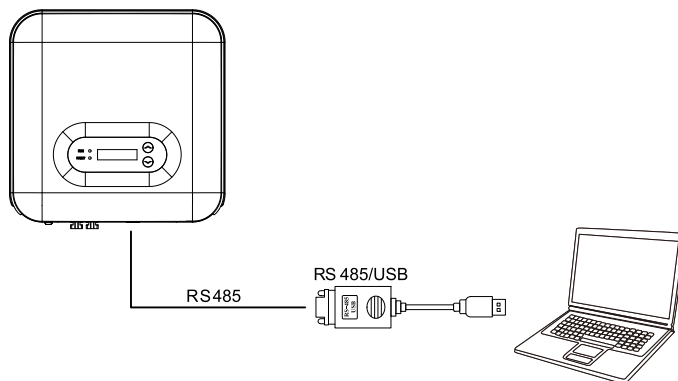

4.5.3 CT interface

Generation and Export Limit Control functions for the inverter are available but require the use of an external measurement device to obtain grid information.

There are 2 ways to obtain grid information:

- Plan A: CT (default)
- Plan B: Meter + CT (optional)

Note: CT and Meter is supplied separately to the inverter. Contact manufacturer/importer/distributor to order CT and/or Meter.

To obtain grid information via Plan A:

Connect the wires according to the wiring method as shown in "Figure 4-17 Plan A", and enable Anti-Reflux Power function and set the Reflux Power limit on the menu interface of the machine. Refer to <6.3 Main Interface→A Enter Setting> in this manual for specific operation methods.

Hard anti-reverse current is enabled by default in some safety Settings. To access the hard anti-reverse current setting, this requires permission from Sofar Solar. Only installers and distributors have the permission to use the Bluetooth APP for setting, enabling/disabling settings, and setting up the Reflux Power limit. Refer to <6.3 Main interface→A Enter Setting> in this manual for specific operation methods.

To obtain grid information via Plan B:

Wiring according to the wiring method as shown in "Figure 4-15 Plan B", and enable Anti-Reflux Power function and set the Reflux Power limit on the menu interface of the machine. Refer to <6.3 Main interface→A Enter Setting> in this manual for specific operation methods.

The setting of hard anti-reverse flow is the same as that of Plan A. The electricity meter function will also need to be enabled via the menu interface of the machine. Refer to <6.3 Main interface→A Enter Setting> in this manual for specific operation methods.

Please Note:

Anti-Reflux Function = Export Limit function

Reflux Power = Export Power

Hard Anti-Reflux control = Hard Export limit control

Anti-Reflux Control = Soft Export limit control

When Anti-Reflux function is enabled, the reflux power of point of common coupling (PCC) will be limited to the set Reflux Power limit. Both Hard Anti-Reflux Control and Anti-Reflux Control can be used together. However, when Hard Anti-Reflux control is enabled, Anti-Reflux power limit cannot exceed the Hard Anti-Reflux power limit. If the Anti-reflux power exceeds the Hard Anti-Reflux power limit, the limit value is reported to trigger the overload protection.

When communication signal with the electricity meter is lost, the output power of the inverter is limited to the value of soft export limit and does not trigger fault protection. When Hard anti reflux control is enabled, a loss of communication with the meter will trigger the inverter into a fault protection state.

Figure 4-17

Plan A: CT (default)

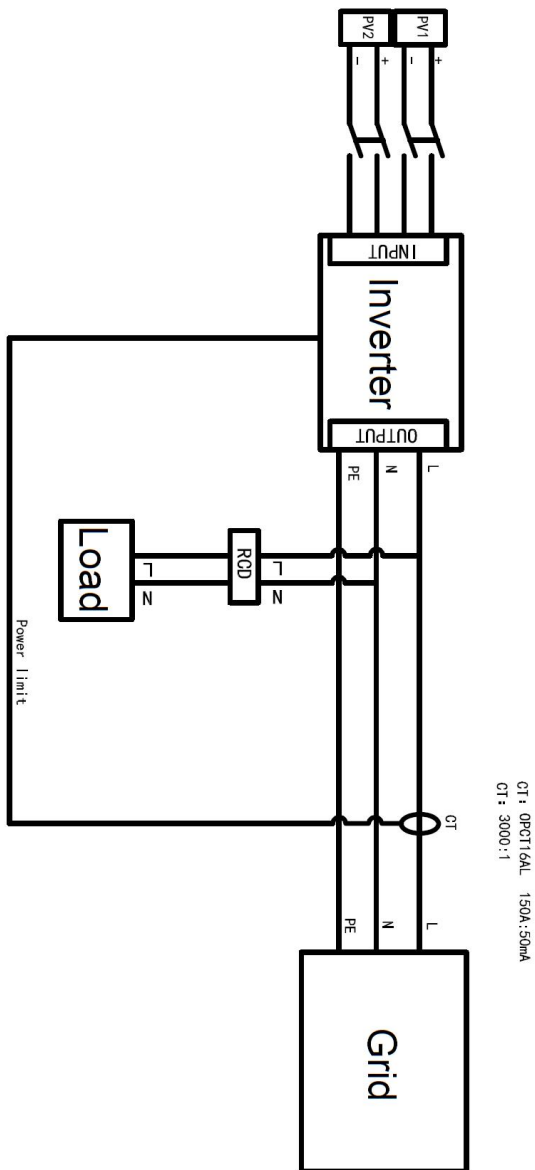

Plan B: Meter+CT (optional)

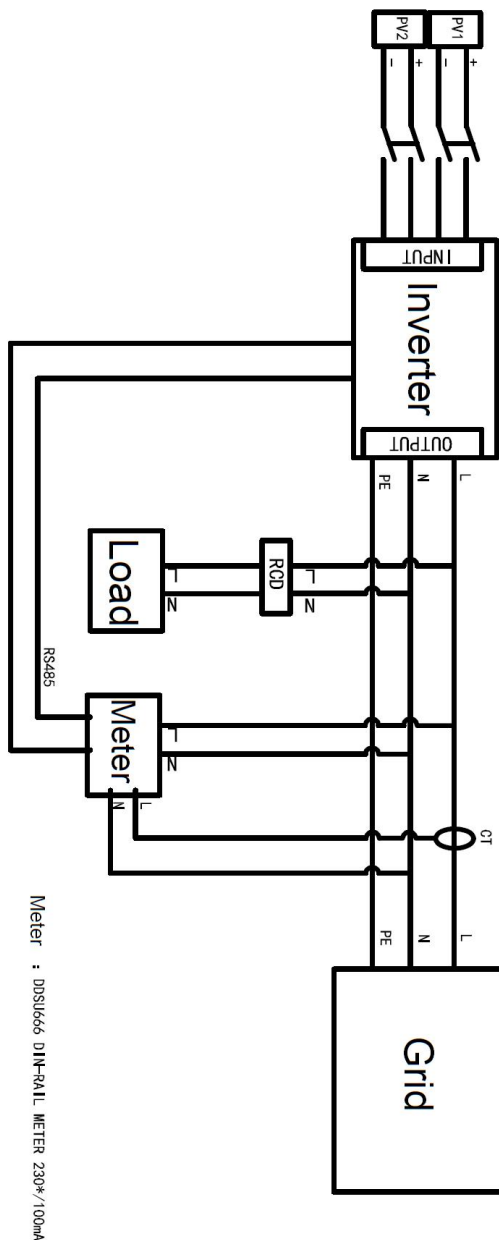

4.6. WIFI/GPRS

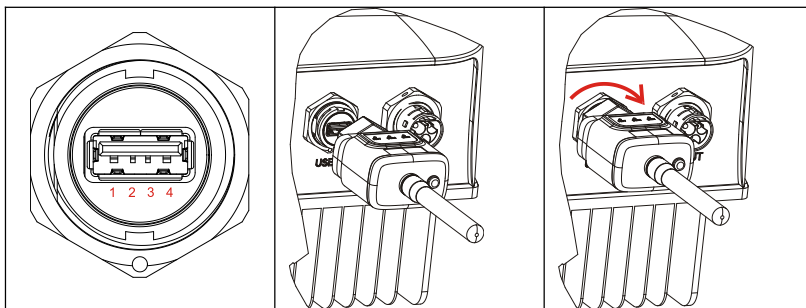
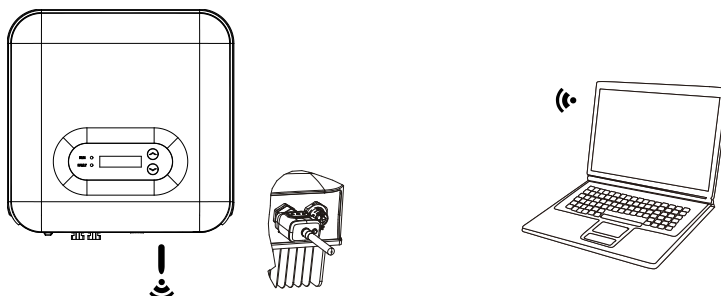

Figure 4-18 Connect one USB acquisition stick (WIFI version) to wireless router



NOTE

The length of the RS485 communication cable should be less than 1000 m.

The length of the WIFI communication cable should be less than 100 m.

If multiple SOFAR 3K~6KTLM-G3 are connected to the monitoring device over an RS485/USB converter, a maximum of 31 inverters can be connected in a daisy chain.

The operation information (generated energy, alert, operation status) of the inverter can be transferred to PC or uploaded to the server via WiFi/GPRS. Users can choose to use web or APP for monitoring and viewing according to their needs. They need to register an account and bind the device with the WiFi/GPRS SN number. The SN number of the WiFi/GPRS shall be affixed to the package box and the WiFi/GPRS.

Web: <https://home.solarmanpv.com> (Recommended browser: Chrome58、Firefox49、IE9)

and above version).

APP: Android: Go to Android Market and search "SolarMAN".

IOS: Go to App Store and search "SolarMAN".

SolarMAN-3.0-Web User Manual, Please visit the <https://doc.solarmanpv.com/web/7>.

SolarMAN-App User Manual, Please visit the <https://doc.solarmanpv.com/web/14>.

5. Commissioning of inverter

5.1. Safety inspection before commissioning



Ensure that DC and AC voltages are within the acceptable range of the inverter.

Attention

5.2. Start inverter

Step 1: Turn ON the DC switch.

Step 2: Turn ON the AC circuit breaker.

When the DC power generated by the solar array is adequate, the SOFAR 3K~6KTLM-G3 inverter will start automatically. Screen showing "normal" indicates correct operation.

Warning: The inverter cannot be used in multiple combinations.

NOTE: Choose the correct country code. (refer to section 6.3 of this manual)

Notice: Different distribution network operators in different countries have different requirements regarding grid connections of PV grid connected inverters.

Therefore, it's very important to make sure that you have selected the correct country code according to requirements of local authority. Please consult qualified electrical engineer or personnel from electrical safety authorities about this.

Detection methods of isolated islands: Reactive Power Disturbance.

Shenzhen SOFAR SOLAR Co. Ltd. is not responsible for any consequences arising out of incorrect country code selection.

If the inverter indicates any fault, please refer to Section 7.1 of this manual —

trouble shooting for help.

NOTE: The inverter monitors the grid power in real time, The grid protection will be triggered when the power grid is abnormal, the inverter is separated from the power grid.

5.3. Shutdown inverter

Step 1: Turn OFF the AC circuit breaker.

Step 2: Turn OFF the DC switch.

5.4. Setting power quality response modes

The setting and viewing method of power quality response mode and power grid protection.

Once the power quality and grid settings have been selected at commissioning, these settings will be locked, end customers cannot modify by themselves. These setting require professional and technical personnel to conduct them by issuing and transmitting instructions on the remote monitoring platform, on the premise that the data acquisition rod is installed (WiFi/GPRS/Ethernet) . And the account must be authorized by SOFARSOLAR.

- Power quality settings can be set/view/changed by logging onto solarmanpv.com.
- Access to solarmanpv.com is restricted to authorised personnel only (refer to Section 4.6 for instructions on accessing solarmanpv.com).
- An account must be created to use solarmanpv.com.
- Technical personnel can send control instructions on the monitoring page to modify the mode and parameters of the machine, and the corresponding instructions need to be provided by internal professionals.

6. Operation interface

Outlines of this chapter

This section introduces the display, operation, buttons and LED indicator lights of SOFAR 3K~6KTLM-G3 Inverter.

6.1. Operation and Display Panel

Buttons and Indicator lights



Button:

“^” Short press UP button = go up

“^” Long press UP button = exit menu or current interface

“v” Short press DOWN button = go down

“v” Long press DOWN button = enter menu or current interface

Indicator Lights:

RUN (Green)

ON: " Normal " state

Flash: " Wait " or " Check "state

FAULT (Red)

ON: " Fault " or " Permanent "state

6.2. Standard Interface



When power-on, LCD interface displays INITIALIZING, refer below picture.



When control board successfully connected with communication board, the LCD display the current state of the inverter as shown in the figure below.

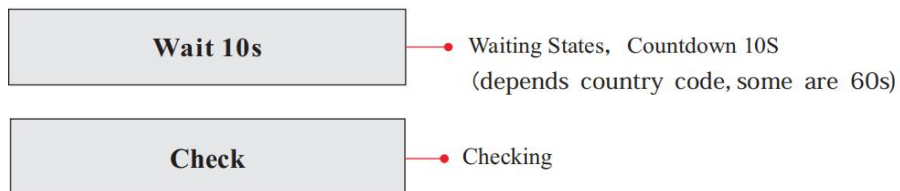

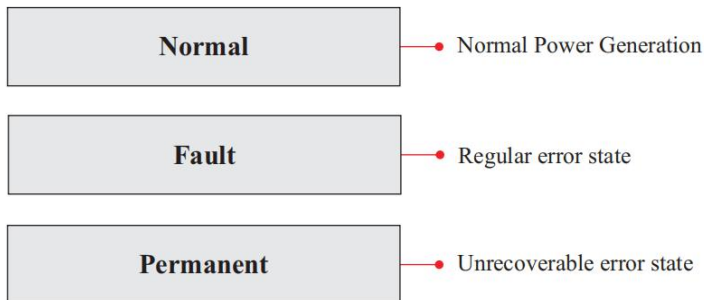

Inverter states includes: wait、 check、 normal、 fault and permanent

Wait: Inverter is waiting to Check State at the end of reconnection time. In this state, grid voltage value is between the max and min limits and so on; If not, Inverter will go to Fault State or Permanent State.

Check: Inverter is checking isolation resistor, relays, and other safety requirements. It also does self-test to ensure inverter software and hardware are functional. Inverter will go to Fault State or Permanent State if any error or fault occurs.

Normal: Inverter enter to Normal State, it is feeding power to the grid; inverter will go to Fault State or Permanent state if any error or fault occurs.

Fault: Fault State: Inverter has encountered recoverable error. It should recover if the errors disappear. If Fault State continues; please check the inverter according error code.

Permanent: Inverter has encountered unrecoverable error, a technician is required to debug the error according to the presented error code.

When the control board and communication board connection fails, the LCD display interface as shown in the figure below.

DSP communicate fail

6.3. Main Interface

Long press the “v” button under standard interface to enter into main interface, including:

Normal	-----Long press the“v”
	1.Enter Setting
	2.Event List
	3.SystemInfo
	4.Display Time
	5.Software Update

(A) "Enter Setting" Interface as below:

1.Enter Setting	-----Long press the“v”	
	1.Set Time	8.Set Input mode
	2.Clear Energy	9.Set Language
	3.Clear Events	10.Set Reflux P
	4.Set Safety Para	11.EnDRMs
	5.On-Off Control	12.IV Curve Scan
	6.Set Energy	13.Autotest Fast
	7.Set Address	14.Autotest STD

Long press the “v” button to Enter the main interface of "1.Enter Setting" and long press the “v” to enter the setting menu. You can switch up and down to choose what you want by short pressing the “^” and “v” .

Note1: Some settings require a password (please contact Sofar technical support for the password) , when entering the password, short press the “^” and “v” to change the number, long press the “v” to confirm the current number, and long press the “v” after entering the correct password. If "password error, try again" appears, you will need to re-enter the correct password.

1. Set Time

Set the system time for the inverter.

2. Clear Energy

Clean the inverter of the total power generation.

3. Clear Events

Clean up the historical events recorded in the inverter.

4. Set SafetyPara

Table 6-1 List of preprogrammed countries(below)

This menu is where you can select the country grid parameters, alternatively you can use the mobile APP. To import a country profile you will require the use of a USB drive. Once you insert a USB drive with a valid file you can then select and import it in the "Set SafetyPara" menu.

To use the Bluetooth APP to select the correct country code, the account must be linked and authorised as an installer. Once the country is set, it is read-only and can only be viewed and not modified by the end user.

Please contact and discuss with SOFARSOLAR technical support if you require a non standard parameter set.

Code		Country	Code		Country
000	000*	Germany VDE4105	024	000	Cyprus
	001	Germany BDEW	025	000	India
	002*	Germany VDE0126	026	000	Philippines
001	000	Italia CEI-021 Internal	027	000	New Zealand
	001*	Italia CEI-016 Italia	028	000	Brazil
	002*	Italia CEI-021 External		001	Brazil LV
	003	Italia CEI0-21 In Areti		002	Brazil 230
002	000	Australia-A		003	Brazil 254
	008	Australia-B	029	000*	Slovakia VSD
	009	Australia-C		001*	Slovakia SSE
003	Spain RD1699	002*		Slovakia ZSD	
004	000*	Turkey	033	000*	Ukraine
005	000	Denmark	034	000	Norway
	001	Denmark TR322		001	Norway-LV
006	000*	Greece Continent	035	000	Mexico LV
	001*	Greece island	038	000	Wide-Range-60Hz
007	000*	Netherland	039	000*	Ireland EN50438
008	000*	Belgium	040	000	Thailand PEA
009	000	UK G59/G99		001	Thailand MEA
	001	UK G83/G98	042	000	LV-Range-50Hz
010	000	China	044	000	South Africa
	001	China Taiwan	046	000*	Dubai DEWG
011	000*	France		001	Dubai DEWG MV

	001	France FAR Arrete23	107	000*	Croatia
012	000	Poland	108	000*	Lithuania
013	000	Austria Tor Erzeuger			
014	000	Japan			
018	000	EU EN50438			
	001*	EU EN50549			
019	000	IEC EN61727			
020	000	Korea			
021	000	Sweden			
022	000	Europe General			

For The Australian Market:

For compliance with AS/NZS 4777.2:2020 please select from

- 002-000 Australia A (Australia Region A)
- 002-008 Australia B (Australia Region B)
- 002-009 Australia C (Australia Region C)

Please contact your local grid operator for which option to select

Note: By selecting 002-000 Australia A, 002-008 Australia B or 002-009 Australia C the power quality response mode and grid protection settings will be reset to their default values for Australia Region A, B, C respectively.

Default grid settings for different regions are shown in the following table:

Protective function	Protective function limit	Trip delay time	Maximum disconnection time
Undervoltage 2(V<<)	70V	1s	2s
Undervoltage 1(V<)	180V	10s	11s
Overvoltage 1(V>)	265V	1s	2s
Overvoltage 2(V>)	275V	-	0.2s

	Region	Australia A	Australia B	Australia C	New Zealand
Under-frequency 1 (F<)	Protective function limit value	47Hz	47Hz	45Hz	45Hz
	Trip delay time	1s	1s	5s	1s
	Maximum disconnection time	2s	2s	6s	2s
Over-frequency 1	Protective function limit	52Hz	52Hz	55Hz	55Hz

(F>)	value				
	Trip delay time	-	-	-	-
	Maximum disconnection time	0.2s	0.2s	0.2s	0.2s

Default volt-watt settings for different regions are shown in the following table:

Region	Default value	V_{L2}	V_{L1}	V_{W1}	V_{W2}
Australia A	Voltage	207	215	253	260
	Inverter output (P) % of S_{rated}	20%	100%	100%	20%
Australia B	Voltage	195	215	250	260
	Inverter output (P) % of S_{rated}	0%	100%	100%	20%
Australia C	Voltage	207	215	253	260
	Inverter output (P) % of S_{rated}	20%	100%	100%	20%

Default volt-var settings for different regions are shown in the following table:

Region	Default value	V_{V1}	V_{V2}	V_{V3}	V_{V4}
Australia A	Voltage	207	220	240	258
	Inverter reactive output (Q) % of S_{rated}	44% supplying	0%	0%	60% sinking
Australia B	Voltage	205	220	235	255
	Inverter reactive output (Q) % of S_{rated}	30% supplying	0%	0%	40% sinking
Australia C	Voltage	215	230	240	255
	Inverter reactive output (Q) % of S_{rated}	44% supplying	0%	0%	60% sinking

5. On-Off Control

Inverter on-off local control.

6. Set Energy

Set the total power generation. You can modify/clear the total power generation through this option.

7. Set Address (default: 01)

Set the address (when you need to monitor multiple inverters simultaneously).

8. Set Input mode (default: independent)

SOFAR 3K~6KTLM-G3 has two MPPT channels, which can run independently or in parallel. The choice between independent or parallel depends on the array layout.

9. Set Language

Selects the menu system language.

10. Set Reflux P

Enable or disable the export limiting function of the inverter. This function requires to be used with an external CT (CT mode) or an external smart meter (ElecM mode, via RS485), please refer to this manual 4.5 CT for details.

“Enter”	1 Enter setting	“OK”	1 Set Time	
	2 Event List		2 Clean Energy	
“Up”↑	3 System Info	“Up”↑	3 Clean Events	
“Down”↓	4 Display Time	“Down”↓	
	5 Software Update		10 Set Reflux P	“OK”
				Input password!

“OK”	****	Input 0001	0001	“OK”	Anti Reflux Control
					Hard Anti Reflux Control

Anti Reflux Control	“OK”	Enable	“OK”	*.**KW	Input the allowable export power
		Disable			
Hard Anti Reflux Control	“OK”	Enable	“OK”	*.**KW	Input the allowable export power
		Disable			

Press “Up” or “Down” to change the value of the first digit. Press “OK” to switch to second digit.

Press “Up” or “Down” to change the value of the second digit. After inputting all digit press “OK” to confirm.

11. EnDRMs

Enable or disable logical interfaces. Please refer to this manual 4.4.1 Logic interface for details.

12. IV Curve Scan

Sets the delay between each full range MPPT scan, useful for partially shaded or complex arrays.

13. Autotest Fast

13.Autotest Fast

OK	Start Autotest	Long press the“v” to start
	Testing 59.S1...	
	↓	Wait
	Test 59.S1 OK!	
	↓	Wait
	Testing 59.S2...	
	↓	Wait
	Test 59.S2 OK!	
	↓	Wait
	Testing 27.S1...	
	↓	Wait
	Test 27.S1 OK!	
	↓	Wait
	Testing 27.S2...	
	↓	Wait
	Test 27.S2 OK!	
	↓	Wait
	Testing 81>S1...	
	↓	Wait
	Test 81>S1 OK!	
	↓	Wait
	Testing 81>S2...	
	↓	Wait
	Test 81>S2 OK!	
	↓	Wait
	Testing 81<S1...	
	↓	Wait
	Test 81<S1 OK!	
	↓	Wait
	Testing 81<S2...	
	↓	Wait
	Test 81<S2 OK!	
	↓	Long press the“v”
	Auto Test OK!	

↓	Short press the“v”
59.S1 threshold 253V 900ms	
↓	Short press the“v”
59.S1: 228V 902ms	
↓	Short press the“v”
59.S2 threshold 264.5V 200ms	
↓	Short press the“v”
59.S2: 229V 204ms	
↓	Short press the“v”
27.S1 threshold 195.5V 1500ms	
↓	Short press the“v”
27.S1: 228V 1508ms	
↓	Short press the“v”
27.S2 threshold 34.5V 200ms	
↓	Short press the“v”
27.S2: 227V 205ms	
↓	Short press the“v”
81>S1 threshold 50.5Hz 100ms	
↓	Short press the“v”
81>S1 49.9Hz 103ms	
↓	Short press the“v”
81>S2 threshold 51.5Hz 100ms	
↓	Short press the“v”
81>S2 49.9Hz 107ms	
↓	Short press the“v”
81<.S1 threshold 49.5Hz 100ms	
↓	Short press the“v”
81<.S1 50.0Hz 105ms	
↓	Short press the“v”
81<.S2 threshold 47.5Hz 100ms	
↓	Short press the“v”
81<.S2 50.1Hz 107ms	

14. Autotest STD

14.Autotest STD Long press the “√”

The test procedure is same as Autotest Fast, but it's much more time consuming.

(B) "Event List"

A list of error(ID) codes and their occurrence time. Events will be listed in reverse chronological order(i.e. most recent first).

Please refer to below picture. Long press the “√” enter into main menu interface, and short press the “√” to turn the page in standard interface, then enter by a long press.

“2.Event List” interface.

2. Event List	
1. Current event	2. History event
Fault information	001 ID04 06150825 (Display: the event sequence number, event ID number, and event occurrence time)

(C) "SystemInfo" Interface as below

3.SystemInfo -----Long press the “√”

1.Inverter Type	7.Input Mode
2.Serial Number	8.Remote State
3.Soft Version	9.Reflux Power
4.Hard Version	10.EnDRMs
5.Country	11.Power Ratio
6.Modbus Address	

The user enters the main menu by long pressing the “√” button, then long press the “√” button to enter "3. SystemInfo". Turning the page down can select the system information to view.

(D) Display Time

Long press the “√” button and short press the button to turn the page in the standard user interface to enter into “4.Display Time”,then long press the “√” button to display the current system time.

(E) Software Update

Users can update the software by USB flashdrive, SOFARSOLAR may provide

an updated software to the user if it is necessary, The user needs to decompress the upgrade file to the an empty USB flash drive in a specific folder for it to update properly. *NOTE* After decompressing the file, a folder named "firmware" will appear in the USB flash drive.

6.4. Update Software

SOFAR 3K~6KTLM-G3 inverters offer software upgrade via USB flash drive to maximise inverter performance and avoid inverter operation error.

Step 1 Insert the USB flash drive into a computer.

Step 2 SOFARSOLAR will send the Software code to the user who needs to update. After user receive the file, please decompress file and cover the original file in USB flash drive.

Step 3 Remove the WiFi logger if it is present

Step 4 Insert the USB flash drive into the USB/WiFi interface.

Step 5

5.Software Update	Input password	Contact Sofar for Password
		Start Update
		Updating DSP1
		Updating DSP2
		Updating ARM

Step 6 If the following errors occur, please retry the update up to 3 times. If this continues, please contact technical support for help.

USB Fault	MDSP File Error	SDSP File Error
ARM File Error	Update DSP1 Fail	Update DSP2 Fail
Update ARM Fail		

Step 7 After the update is completed, turn off the DC breaker, wait for the LCD screen to turn off, then restore the WiFi logger and then turn on the DC breaker and AC breaker again, the inverter should resume normal operation. Users can check the current software version in SystemInfo > SoftVersion.

7. Troubleshooting

Outlines of this chapter

This section describes how to perform daily maintenance and troubleshooting to ensure long term proper operation of the inverter.

7.1. Troubleshooting

This section contains information and procedures for solving possible problems with the inverter.

➤ This section helps users to identify the inverter fault. Please read the following procedures carefully:

✧ Check the warning, fault messages or fault codes shown on the inverter screen, record all the fault information.

✧ If there is no fault information shown on the screen, check whether the following requirements are met:

- Is the inverter mounted in a clean, dry place with good ventilation?
- Is the DC switch turned ON?
- Are the cables adequately sized and short enough?
- Are the input and output connections and wiring in good condition?
- Are the configuration settings correct for the particular installation?
- Are the display panel and the communication cables properly connected and undamaged?

Follow the steps below to view the error logs: Long press the button to enter the main menu from the standard interface. Select "2. Event List" then long press the button to enter event list.

➤ Earth Fault Alarm

This inverter complies with AS/NZS 5033 for earth fault alarm monitoring.

If an Earth Fault Alarm occurs, the fault will be displayed on the LCD

screen, the red light will be on and , and the fault can be found in the history of the fault. For the machine installed with Wi-Fi/GPRS, the alarm information can be seen on the corresponding monitoring website, and can also be received by the APP on the mobile phone.

Table 7-1 Event list

Code	Name	Description	Solution
ID001	GridOVP	The grid voltage is too high	If the alarm occurs occasionally, the possible cause is that the electric grid is abnormal. Inverter will automatically return to normal operating status when the electric grid is back to normal.
ID002	GridUVP	The grid voltage is too low	
ID003	GridOFP	The grid frequency is too high	
ID004	GridUFP	The grid frequency is too low	<p>If the alarm occurs frequently, check whether the grid voltage/frequency is within the acceptable range. If yes, please check the AC circuit breaker and AC wiring of the inverter.</p> <p>If the grid voltage/frequency is NOT within the acceptable range and AC wiring is correct, but the alarm occurs repeatedly, contact technical support to change the grid over-voltage, under-voltage, over-frequency, under-frequency protection points after obtaining approval from the local electrical grid operator.</p>
ID005	GFCI	Charge Leakage Fault	<p>Internal faults of inverter, switch OFF inverter, wait for 5 minutes, then switch ON inverter. Check whether the problem is solved.</p> <p>If no, please contact technical support.</p>
ID006	OVRT fault	OVRT function is faulty	
ID007	LVRT fault	LVRT function is faulty	
ID008	IslandFault	Island protection error	
ID009	GridOVPInstant1	Transient overvoltage of grid voltage 1	
ID010	GridOVPInstant2	Transient overvoltage of grid voltage 2	
ID011	VGridLineFault	Power grid line voltage error	
ID012	InvOVP	Inverter voltage overvoltage	
ID017	HwADFaultGrid	Power grid current sampling error	

ID018	HwADFaultDCI	Wrong sampling of dc component of grid current	
ID019	HwADFaultVGri d(DC)	Power grid voltage sampling error (DC)	
ID020	HwADFaultVGri d(AC)	Power grid voltage sampling error (AC)	
ID021	GFCIDeviceFault (DC)	Leakage current sampling error (DC)	
ID022	GFCIDeviceFault (AC)	Leakage current sampling error (AC)	
ID023	HwADFaultDCV	Error in dc component sampling of load voltage	
ID024	HwADFaultIdc	Dc input current sampling error	
ID029	ConsistentFault_ GFCI	Leakage current consistency error	
ID030	ConsistentFault_ Vgrid	Grid voltage consistency error	
ID033	SpiCommFault(D C)	SPI communication error (DC)	
ID034	SpiCommFault(A C)	SPI communication error (AC)	
ID035	SChip_Fault	Chip error (DC)	
ID036	MChip_Fault	Chip error (AC)	
ID037	HwAuxPowerFau lt	Auxiliary power error	
ID041	RelayFail	Relay detection failure	
ID042	IsoFault	Low insulation impedance	Check the insulation resistance between the photovoltaic array and ground (ground), if there is a short circuit, the fault should be repaired in time.
ID043	PEConnectFault	Ground fault	Check ac output PE wire for grounding.
ID044	PV Config Error	Error setting input mode	Check the PV input mode (parallel/independent mode) Settings for the inverter. If not, change the PV input mode.
ID045	CTD isconnect	CT error	Check whether the CT wiring is correct.
ID049	TempFault_Bat	Battery temperature	Make sure the inverter is installed

		protection	where there is no direct sunlight.	
ID050	TempFault_Heat Sink1	Radiator 1 temperature protection	Please ensure that the inverter is installed in a cool/well ventilated place. Ensure the inverter is installed vertically and the ambient temperature is below the inverter temperature limit.	
ID051	TempFault_Heat Sink2	Radiator 2 temperature protection		
ID052	TempFault_Heat Sin3	Radiator 3 temperature protection		
ID053	TempFault_Heat Sink4	Radiator 4 temperature protection		
ID054	TempFault_Heat Sin5	Radiator 5 temperature protection		
ID055	TempFault_Heat Sin6	Radiator 6 temperature protection		
ID057	TempFault_Env1	Ambient temperature 1 protection		
ID058	TempFault_Env2	Ambient temperature 2 protection		
ID059	TempFault_Inv1	Module 1 temperature protection		
ID060	TempFault_Inv2	Module 2 temperature protection		
ID061	TempFault_Inv3	Module 3 temperature protection		
ID065	VbusRmsUnbalance	Unbalanced bus voltage RMS		Internal faults of inverter, switch OFF inverter, wait for 5 minutes, then switch ON inverter. Check whether the problem is solved. If no, please contact technical support.
ID066	VbusInstantUnbalance	The transient value of bus voltage is unbalanced		
ID067	BusUVP	Busbar undervoltage during grid-connection		
ID068	BusZVP	Bus voltage low		
ID069	PVOVP	PV over-voltage	Check whether the PV series voltage (Voc) is higher than the maximum input voltage of the inverter. If so, adjust the number of PV modules in series and reduce the PV series voltage to fit the input voltage range of the inverter. After correction, the inverter will automatically return to its normal state.	
ID070	BatOVP	Battery over-voltage	Check whether the battery overvoltage setting is inconsistent with the battery specification.	

ID071	LLCBusOVP	LLC BUS overvoltage protection	Internal faults of inverter, switch OFF inverter, wait for 5 minutes, then switch ON inverter. Check whether the problem is solved. If no, please contact technical support.
ID072	SwBusRmsOVP	Inverter bus voltage RMS software overvoltage	
ID073	SwBusInstantOVP	Inverter bus voltage instantaneous value software overvoltage	
ID081	SwBatOCP	Battery overcurrent software protection	
ID082	DciOCP	Dci overcurrent protection	
ID083	SwOCPInstant	Output instantaneous current protection	
ID084	SwBuckBoostOCP	BuckBoost software flow	
ID085	SwAcRmsOCP	Output effective value current protection	
ID086	SwPvOCPInstant	PV overcurrent software protection	
ID087	IpvUnbalance	PV current is not consistent in parallel	
ID088	IacUnbalance	Unbalanced output current	
ID097	HwLLCBusOVP	LLC bus hardware overvoltage	
ID098	HwBusOVP	Inverter bus hardware overvoltage	
ID099	HwBuckBoostOCP	BuckBoost hardware overflows	
ID100	HwBatOCP	Battery hardware overflows	
ID102	HwPV OCP	PV hardware overflows	
ID103	HwAC OCP	Ac output hardware overflows	
ID110	Overload1	Overload protection 1	Please check whether the inverter is operating under overload.
ID111	Overload2	Overload protection 2	
ID112	Overload3	Overload protection 3	
ID113	OverTempDerating	Internal temperature is too high.	Make sure the inverter is installed where there is no direct sunlight. Please ensure that the inverter is installed in a cool/well ventilated place.

			Ensure the inverter is installed vertically and the ambient temperature is below the inverter temperature limit.
ID114	FreqDerating	AC frequency is too high	Please make sure the grid frequency and voltage is within the acceptable range.
ID115	FreqLoading	AC frequency is too low	
ID116	VoltDerating	AC voltage is too high	
ID117	VoltLoading	AC voltage is too low	
ID124	BatLowVoltageAlarm	Battery low voltage protection	Please check whether the battery voltage of the inverter is too low.
ID125	BatLowVoltageShut	Battery low voltage shutdown	
ID129	unrecoverHwAcOCP	Output hardware overcurrent permanent failure	Internal faults of inverter, switch OFF inverter, wait for 5 minutes, then switch ON inverter. Check whether the problem is solved. If no, please contact technical support.
ID130	unrecoverBusOVP	Permanent Bus overvoltage failure	
ID131	unrecoverHwBusOVP	Permanent Bus hardware overvoltage failure	
ID132	unrecoverIpyUnbalance	PV uneven flow permanent failure	
ID133	unrecoverEPSBatOCP	Permanent battery overcurrent failure in EPS mode	
ID134	unrecoverAcOCPInstant	Output transient overcurrent permanent failure	
ID135	unrecoverIacUnbalance	Permanent failure of unbalanced output current	
ID137	unrecoverPvConfigError	Input mode setting error permanent failure	
ID138	unrecoverPVOCPInstant	Input overcurrent permanent fault	
ID139	unrecoverHwPVOCP	Input hardware overcurrent permanent failure	
ID140	unrecoverRelayFail	Permanent relay failure	Internal faults of inverter, switch OFF inverter, wait for 5 minutes, then switch ON inverter. Check whether the problem is solved. If no, please contact technical support.
ID141	unrecoverVbusU	Bus voltage unbalanced	

	nbalance	permanent failure	
ID145	USBFault	USB fault	Check the USB port of the inverter
ID146	WifiFault	Wifi fault	Check the Wifi port of the inverter
ID147	BluetoothFault	Bluetooth fault	Check the bluetooth connection of the inverter
ID148	RTCFault	RTC clock failure	Internal faults of inverter, switch OFF inverter, wait for 5 minutes, then switch ON inverter. Check whether the problem is solved. If no, please contact technical support.
ID149	CommEEPROM Fault	Communication board EEPROM error	
ID150	FlashFault	Communication board FLASH error	
ID153	SciCommLose(DC)	SCI communication error (DC)	
ID154	SciCommLose(AC)	SCI communication error (AC)	
ID155	SciCommLose(Fuse)	SCI communication error (Fuse)	
ID156	SoftVerError	Inconsistent software versions	Contact for technical support and software upgrades.
ID157	BMSCommunicationFault	Communication failure of lithium battery	Make sure your battery is compatible with the inverter. CAN communication is recommended. Check the communication line or port of the battery and inverter for faults.
ID161	ForceShutdown	Force shutdown	The inverter is performed a forced shutdown
ID162	RemoteShutdown	Remote shutdown	The inverter is performed a remote shutdown.
ID163	Drms0Shutdown	Drms0 shutdown	The inverter is performed with a Drms0 shutdown.
ID165	RemoteDerating	Remote derating	The inverter is performed for remote load reduction.
ID166	LogicInterfaceDerating	Logic interface derating	The inverter is loaded by the execution logic interface.
ID167	AlarmAntiRefluxing	Anti reflux derating	The inverter is implemented to prevent countercurrent load drop.
ID169	FanFault1	Fan 1 fault	Please check whether the fan 1 of inverter is running normally.
ID170	FanFault2	Fan 2fault	Please check whether the fan 2 of inverter is running normally.
ID171	FanFault3	Fan 3 fault	Please check whether the fan 3 of inverter is running normally.
ID172	FanFault4	Fan 4 fault	Please check whether the fan 4 of

			inverter is running normally.
ID173	FanFault5	Fan 5 fault	Please check whether the fan 5 of inverter is running normally.
ID174	FanFault6	Fan 6 fault	Please check whether the fan 6 of inverter is running normally.
ID177	BMS OVP	BMS over-voltage alarm	Internal failure of lithium battery, close inverter and lithium battery, and wait 5 minutes to open inverter and lithium battery. Check that the problem is resolved. If not, please contact technical support.
ID178	BMS UVP	BMS under-voltage alarm	
ID179	BMS OTP	BMS high temperature warning	
ID180	BMS UTP	BMS low temperature alarm	
ID181	BMS OCP	Warning of overload in charge and discharge of BMS	
ID182	BMS Short	BMS short circuit alarm	

7.2. Maintenance

Inverters generally do not need any daily or routine maintenance. Heat sink should not be blocked by dust, dirt or any other items. Before cleaning, make sure that the DC SWITCH is turned OFF and the circuit breaker between inverter and electrical grid is turned OFF. Wait at least for 5 minutes before the Cleaning.

✧ Inverter cleaning

Please clean the inverter with an air blower, a dry & soft cloth or a soft bristle brush. Do NOT clean the inverter with water, corrosive chemicals, detergent, etc.

✧ Heat sink cleaning

For the long-term proper operation of inverters, ensure there is enough space around the heat sink for ventilation, check the heat sink for blockage (dust, snow, etc.) and clean them if they exist. Please clean the heat sink with an air blower, a dry & soft cloth or a soft bristle brush. Do NOT clean the heat sink with water, corrosive chemicals, detergent, etc.

8. Technical data

Outlines of this chapter

This topic lists the technical specifications for all SOFAR 3K~6KTLM-G3 inverters.

8.1. Input parameters (DC)

Technical Data	SOFAR 3KTLM -G3	SOFAR 3.6KTL M-G3	SOFAR 4KTLM -G3	SOFAR 4.6KTL M-G3	SOFAR 5KTLM -G3	SOFAR 5KTLM -G3-A	SOFAR 6KTLM- G3
Recommended Max.PV input power	4500Wp	5400Wp	6000Wp	7000Wp	7500Wp	7500Wp	9000Wp
MAX. DC power for single MPPT	3500W	3500W	3500W	3500W	3750W	3750W	4500W
Number of MPP trackers	2						
Number of DC input	1 for each MPPT						
Max. input voltage	600V						
Start-up voltage	90V						
Rated input voltage	380V						
MPPT operating voltage range	80V~550V						
Full power MPPT voltage range	200V~ 500V	200V~ 500V	200V~ 500V	200V~ 500V	210V~ 500V	210V~ 500V	260V~ 500V
Max. Input MPPT current	15A/15A						
Isc PV (absolute maximum)	22.5A/22.5A						
Maximum inverter backfeed current to array	No backfeed current to array						

8.2. Output parameters (AC)

Technical Data	SOFAR 3KTLM-G3	SOFAR 3.6KTL-M-G3	SOFAR 4KTLM-G3	SOFAR 4.6KTL-M-G3	SOFAR 5KTLM-G3	SOFAR 5KTLM-G3-A	SOFAR 6KTLM-G3
Rated power	3000VA	3680VA	4000VA	4600VA	5000VA	5000VA	6000VA
Max.AC power	3300VA	3680VA	4400VA	4600VA	5500VA	5000VA	6000VA
Rated Apparent power	3300VA	3680VA	4400VA	4600VA	5500VA	5000VA	6000VA
Nominal output current	13.6A	16A	18.2A	21A	22.7A	21.7A	27.3A
Max.output current	15A	16A	20A	23A	25A	21.7A	29A
Nominal grid voltage	L/N/PE, 220Vac 230Vac 240Vac						
Grid voltage range	180-276Vac (According to local grid standard)						
Nominal grid frequency	50Hz/60Hz						
Grid frequency range	45~55Hz/54~66Hz (According to local grid standard)						
Active power adjustable range	0~100%						
THDi	<3%						
Power factor	1 default(+0.8 adjustable)						
Power limit export	Zero export or adjustable power limit export						
Current (inrush)	200A _{ac} , 1μs						
Maximum output fault current	59A /20ms						
Maximum output overcurrent protection	27.3A _{ac}						
backfeed current	0A						
Detection methods of isolated islands	Reactive Power Disturbance						

8.3. Efficiency, Protection and Communication

Technical Data	SOFAR 3KTLM-G3	SOFAR 3.6KTL M-G3	SOFAR 4KTLM-G3	SOFAR 4.6KTL M-G3	SOFAR 5KTLM-G3	SOFAR 5KTLM-G3-A	SOFAR 6KTLM-G3
Max. efficiency	98.2%	98.2%	98.2%	98.4%	98.4%	98.4%	98.4%
Euro efficiency	97.3%	97.3%	97.3%	97.5%	97.5%	97.5%	97.5%
MPPT efficiency	99.9%						
Self-consumption at night	<1W						
DC reverse polarity protection	Yes						
DC switch	Optional						
AFCI protection	Optional						
Protective class/overvoltage category	I/III						
Safety protection	Anti islanding, RCMU, Ground fault monitoring						
SPD	MOV: Type III standard						
Power management unit	According to certification and request						
Communication	RS485/USB/Bluetooth, Optional: WiFi/GPRS						
Operation data storage	25 years						

8.4. General Date

Technical Data	SOFAR 3KTLM-G3	SOFAR 3.6KTL M-G3	SOFAR 4KTLM-G3	SOFAR 4.6KTL M-G3	SOFAR 5KTLM-G3	SOFAR 5KTLM-G3-A	SOFAR 6KTLM-G3
Topology	transformer-less						
Ambient temperature range	-30~60°C						
Degree of protection	IP65						
Allowable relative humidity range	0~100%						
Noise	<25dB						
Cooling	Natural Convection						
Max.operating altitude	2000m						
Outline Dimension	349*344*164mm						
Weight	9.2kg			10kg			
Display	LCD&Bluetooth+APP						
Warranty	10 years						
Over voltage category	DC side: overvoltage II AC side: overvoltage III						
EMC	EN 61000-6-2, EN 61000-6-3, EN 61000-3-2, EN 61000-3-3, EN 61000-3-11, EN 61000-3-12						
Safety standards	IEC 62109-1/2, IEC 62116, IEC 61727, IEC 61683, IEC 60068(1,2,14,30)						
Grid standards	VDE-AR-N 4105, VDE V 0126-1-1, V 0124-100, AS/NZS 4777, CEI 0-21, G98/G99, C10/11, EN 50549, RD 1699						

9. Quality Assurance

SOFARSOLAR *Factory's Warranty Terms and Conditions for Australia

Applicable products

These *Factory's Warranty Terms and Conditions (“Terms and Conditions”) only applies to the following products, which are distributed and installed in Australia.

Table

Product	Standard warranty period (months)
Inverter	
GRID-TIED (SOFAR 3K~6KTLM-G3)	120
Accessories	
CT Clamp	24
smart Meter	24
WIFI dongle	24

This factory warranty is a promise from SOFARSOLAR to its end users on the applicable products listed above.

Definitions

In these Terms and Conditions:

- a) “ACL” means Schedule 2 to the Competition and Consumer Act 2010 (Cth);

- b) “Claim” means any judgment, claim, demand, action, suit or proceeding for damages, debt, restitution, equitable compensation, account, injunctive relief, specific performance or any other remedy, whether by original claim, cross claim or otherwise whether arising at common law, in equity, under statute or otherwise wherever arising, whether known or unknown at the time of these

Terms and Conditions, whether presently in contemplation of the parties or not;

c) "Consequential Loss" means loss or damage, whether direct or indirect, in the nature of, among other things, loss of profits, loss of revenue, loss of production, liabilities in respect of third parties (whether contractual or not), loss of anticipated savings or business, pure economic loss, loss of opportunity and any form of consequential, special, indirect, punitive or exemplary loss or damages, whether or not a party was advised of the possibility of such loss or damage;

d) "End User" means a person or entity whose order for the purchase of the Product is accepted by SOFARSOLAR;

e) "Loss" means, in relation to any person, any damage, loss, cost, expense or liability incurred by the person or arising from any Claim, action, proceedings or demand made against the person, however arising and whether present or future, fixed or ascertained, actual or contingent and includes Consequential loss;

f) "Product" means any applicable product or products distributed and installed by SOFARSOLAR to the End User as set out in the Table of these Terms and Conditions;

g) "Warranty Period" means the applicable warranty period of the relevant Product as stipulated in the Table of these Terms and Conditions.

Warranty Conditions

Our goods come with guarantees that cannot be excluded under the ACL. You are entitled to a replacement or refund for a major failure and for compensation for any other reasonably foreseeable loss or damage. You are also entitled to have the goods repaired or replaced if goods fail to be of acceptable quality and the failure does not amount to a major failure. Subject to any statutory rights which cannot be excluded (including the ACL) and the terms of any warranty stipulated in these Terms and Conditions, the End User acknowledges that: prior to purchasing the Product, the End User conducted a thorough examination

of the Product;

- b) SOFARSOLAR made no warranty, condition, description, or representation in relation to the Product outside those contained in these Terms and Conditions;
- c) all warranties, conditions, guarantees, and terms in relation to the state, quality or fitness of the Product and of every other kind whether expressed or implied by use, statute or otherwise are excluded.

To the fullest extent that SOFARSOLAR is able to limit the remedies available under these Terms and Conditions, SOFARSOLAR expressly limits its liability for any breach of a condition or warranty implied by virtue of any applicable legislation (including the ACL) to the following remedies in the event SOFARSOLAR decides a Product to be faulty or otherwise defective during the Warranty Period (or otherwise):

- a) The repair of the Product by SOFARSOLAR whether on-site or off-site;
- b) The replacement of the Product;
- c) The payment of the costs of having the Product repaired.

The payment of the costs of replacing the Product or acquiring equivalent goods. If the Product needs to be replaced, the balance of the Factor's Warranty Period will be applied and transferred to the replacement Product and will continue until its expiry. In this event, the End User will not receive any new warranty card or be entitled to a further Warranty Period, and the replacement Product(s) will be registered by SOFARSOLAR.

Unless otherwise agreed in writing by the parties, the Factory warranty exclusively covers the cost of one (1) freight to the End User, labour and material necessary to regain a faultless functioning Product. The Factory warranty does not cover, without limitation, Consequential Loss, repair reimbursement costs, transport costs, travel costs, accommodation cost of SOFARSOLAR personnel as well as any costs of associated third party staff and personnel. Express delivery costs will not be covered.

In the event SOFARSOLAR, in its sole discretion, decides that any faulty or otherwise defective Product will be repaired on-site or otherwise replaced, in

some service areas or business cases, to encourage the End User using the installer's facilities to receive a faultless and functioning product, SOFARSOLAR may, in its sole discretion, offer a rebate to the End User or local installer/electrician to cover the on-site service labour under the following conditions:

The rebate will be eligible ONLY to the party who has carried out on-site service for the purported faulty or otherwise defective Product;

The purported faulty or otherwise defective Product has been returned in the original replacement product packaging to SOFARSOLAR and deemed to have workmanship or material defects upon testing and inspection by SOFARSOLAR. If the purported faulty or otherwise defective Product is deemed free of faults and defects that would qualify a replacement under these Terms and Conditions, then SOFARSOLAR is entitled to charge a retail price of the Product(s), shipping and packaging and any associated labour cost in replacing the purported faulty or otherwise defective Product;

SOFARSOLAR must be contacted prior to the site visit for authorisation. If the site is not located in a metropolitan area in Australia or if the installer is unable to be on-site, the End User must engage their own electrician to carry out and complete the on-site service;

The service rebate must be claimed strictly within two (2) months of the date upon which the on-site service is authorised by SOFARSOLAR.

SOFARSOLAR retains the right to arrange the warranty service for the End User and to use third parties for performing any warranty services. SOFARSOLAR retains full title and ownership of the supplied replacement Product(s) until the purported faulty or otherwise defective Product has been received in accordance with these terms and conditions.

The End User may contact the dealer (SOFARSOLAR authorised dealer or

distributor) or installer if the Product is faulty or otherwise defective.

All other purported costs including, but not limited to, compensation from any direct or indirect Loss arising from the faulty or otherwise defective Product or other facilities of the PV system, or loss of electrical power generated during the product downtime are NOT covered by the SOFARSOLAR limited warranty.

Scope of the Warranty

The warranty stipulated in these Terms and Conditions will not apply if SOFARSOLAR, in its sole discretion, decides that any one (1) of the following occurs:

The End user is in default under the General Terms and Conditions of other agreement governing the purchase of the Product, or

Any damage or defect to the Product is caused any one (1) or more of the following situations (the Dealers or Distributors are responsible and authorized by SOFARSOLAR for the following investigation):

Disassembly, attempted repair or modifications performed by any person not authorised by SOFARSOLAR in writing, or serial number or seals have been removed. Product modifications, design changes or part replacements without prior written approval of SOFARSOLAR;

The End user or installer has failed, refused or otherwise neglected to comply with the applicable safety regulations (IE, VDE standards or equivalent) governing the proper use of the Product in force from time to time;

The Product has been improperly stored and damaged by the dealer, distributor or the End User;

The fault or otherwise defect is damage sustained during transportation (including painting scratch caused by movement inside packaging during shipping). A Claim for such transport damage should be made directly to the shipping company/insurance company as soon as the container/package is unloaded and such damage is identified;

The Product has been used and installed by an unauthorised or unlicensed installer who fails, refuses, or otherwise neglects to strictly follow any

applicable user manual, installation guide and maintenance regulations supplied with the Product, including not ensuring sufficient ventilation for the Product as described in SOFARSOLAR installation guide;

Defects, faults, cosmetics or rendered non-functional damage caused by unforeseen circumstances, or force majeure event including, but not limited to, any vandalism, violent or stormy weather, lightning, flooding, power fluctuation, overvoltage, grid power surge, pests, fire damage, wind damage, or exposure to erosion, sea coasts/saltwater or other aggressive atmospheres or environmental conditions;

Use of the Product in combination with any unauthorised products, equipment or materials as per the user manual, installation guide and maintenance regulations supplied with the Product;

Combining the Product with any lead acid battery pack or any other lithium battery pack that is not listed on any SOFARSOLAR's battery compatibility list from time to time.

Limitation of Liability

a) This limited warranty supersedes and otherwise replaces any different SOFARSOLAR warranties and liabilities, whether oral, in writing, (non-obligatory) statutory, contractual, in tort or otherwise, consisting of, without quardary, and where permitted by using relevant law, any implied conditions, warranties or different phrases as regards exemplary quality or fitness for purpose. However, this limited warranty shall neither exclude nor limit any of your legal (statutory) rights provided under the relevant national laws and regulations.

b) Subject to clauses 4(c) and (d):

i. all warranties, descriptions, representations, guarantees or conditions, whether express or implied by law, trade, custom or otherwise, and all specific conditions, even though such conditions may be known to SOFARSOLAR, are, to the fullest extent, expressly excluded;

ii. SOFARSOLAR is not liable for any delay or Loss arising from the supply of or failure to supply the Product or comply with an order of the End User whether due to shortfall, defect, incorrect delivery or otherwise for any reason whatsoever including breach of contract (including fundamental breach), negligence, breach of duty as bailee, or the wilful act or default of SOFARSOLAR.

c) These Terms and Conditions shall not exclude or limit the application of any provisions of any statute including any implied condition or warranty the exclusion of which would contravene any statute (including the ACL) or cause any part of this clause 4 to be illegal, invalid, void or unenforceable.

d) If the exclusion of liability in clause 4(b) is reduced, void or not available, SOFARSOLAR's liability for any Claims arising out of these Terms and Conditions, including liability for breach of these Terms and Conditions, in negligence or in tort or for any other common law or statutory action, shall:

i. be limited to the extent the Loss the subject of the Claim was caused directly by SOFARSOLAR; and

ii. in all events, exclude Loss relating to any delay in supply of the Product and for any Consequential Loss.

e) SOFARSOLAR guarantees the performance of the Product under the normal working conditions within the standard warranty term and provide limited technical support if applicable. However, SOFARSOLAR shall assume no liability for system malfunctions and any incurred loss or damages whatsoever.

Please refer to SOFARSOLAR Energy Storage Warranty Terms and Conditions for further information on SOFARSOLAR Energy Storage products.

Procedure for Claiming a Warranty

In the case of a faulty or otherwise defective Product please report that Product within the agreed warranty period, with a detailed error description to SOFARSOLAR's service hotline for registering and send the claim to SOFARSOLAR service department by fax/email or through SOFARSOLAR Warranty Claim Website at <https://service.sofarsolar.com/warranty/search> to process the warranty claim. The End User may also contact the dealer (SOFARSOLAR authorised dealer or distributor) or installer if the Product is defective or faulty.

To make a claim under the warranty, the End User must provide the following information and documentation of the faulty or otherwise defective Product:

Product Model and serial number

A copy of the valid purchasing invoice

Fault descriptions and error IDs (where applicable)

End user and/or claimant details

Detailed information about the entire system (module, PV system diagram, installation date, etc.)

Documentation of previous claims/exchanges (if applicable)

The warranty may not be guaranteed if the above information is not provided.

Extension of the Warranty Period

For SOFARSOLAR inverters, the End User may apply for a Warranty Period extension within 24 months for grid-tied inverter <50kW and 12 months for grid-tied ≥50 kW and energy storage inverter(hybrid) inverters from the date of production from SOFARSOLAR by providing the serial number and copy of the

warranty card of the Product. SOFARSOLAR may reject any application received which does not meet the date requirement. An extended Warranty Period can be purchased to 10, 15, or 20 years. Please refer to the Warranty Extension Order Form for more information.

Once the purchase of the Warranty Period extension has been processed, SOFARSOLAR will send a Warranty Period extension certificate to the End User confirming the extended Warranty Period.

Any faults or defects that occur after the expiry of the Warranty Period, or which occur within the Warranty Period but which are listed in the warranty exceptions above, are deemed to be out-of-warranty cases. For all out-of-warranty cases, SOFARSOLAR, in its sole discretion, may charge fees to the End User including, without limitation:

- a) On-site service fee: cost of travel and time for the technician to deliver on-site service and labour cost for the technician, who is repairing, performing maintenance on, installing (hardware or software) and debugging the faulty product.
- b) Parts/materials fee: cost of replacement parts/materials (including any shipping/admin fee that may apply).
- c) Logistics fee: cost of delivery and any other expenses incurred when defective products are sent from the user to SOFARSOLAR or/and repaired products are sent from SOFARSOLAR to the user.

Latest information about the warranty terms and conditions and local service hotline can be obtained from our website: www.sofarsolar.com.au

Our goods come with guarantees that cannot be excluded under the Australian Consumer Law. You are entitled to a replacement or refund for a major failure and compensation for any other reasonably foreseeable loss or damage. You are also entitled to have the goods repaired or replaced if the goods fail to be of acceptable quality and the failure does not amount to a major failure.

Contact us

You can directly contact our professional after-sales team:

Sofarsolar Ausco Pty Ltd.

Tel: +61 401 734 463 / 408 500 386

Shenzhen Sofarsolar Co. Ltd.



Product Name: Solar Grid-tied Inverter

Company Name: Shenzhen SOFARSOLAR Co., Ltd.

ADD: 401, Building 4, AnTongDa Industrial Park, District 68, XingDong Community,
XinAn Street, BaoAn District, Shenzhen, Guangdong.P.R. China

Email: service@sofarsolar.com

Tel: 0510-6690 2300

Web: www.sofarsolar.com